

BONENG

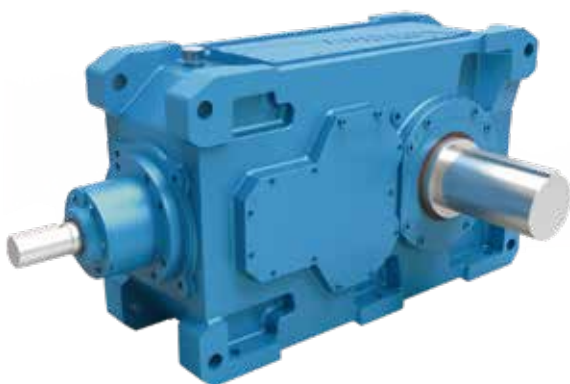

中文

H斜齿齿轮箱
&B锥齿-斜齿
齿轮箱使用
手册

H Helical
Gearbox
&B Bevel-helical
Gearbox
Use Manual

EN

05/2024

齿轮箱型号

H204~H218 B204~B218
H305~H318 B304~B318
H407~H418 B405~B418

H...HS

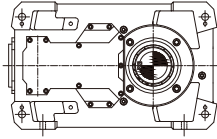

B...HS

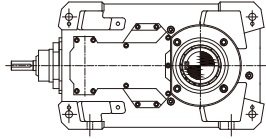

H...HH

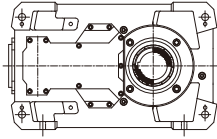

B...HH

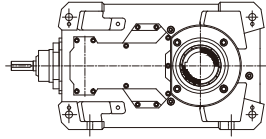

H...HD

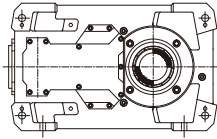

B...HD

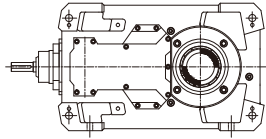

H...HK

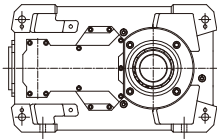

B...HK

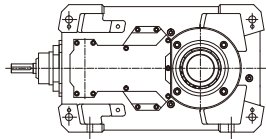

齿轮箱型号

H204~H218 B204~B218

H305~H318 B304~B318

H407~H418 B405~B418

H...VS

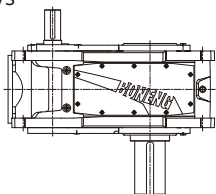

B...VS

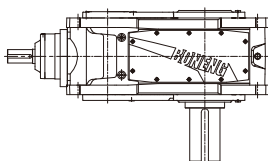

H...VH

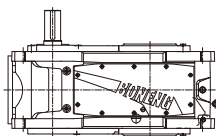

B...VH

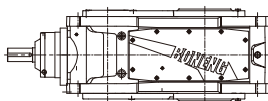

H...VD

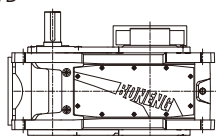

B...VD

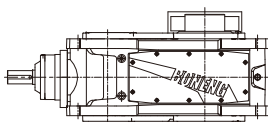

H...VK

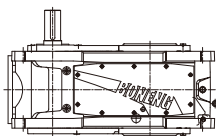

B...VK

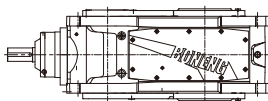

齿轮箱型号

H219~H226

H319~H326 B319~B326

H419~H426 B419~B426

H...HS

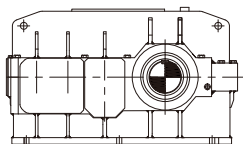

B...HS

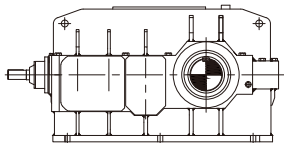

目录

重要提示	01
1 安全说明	01
2 技术说明	02
2.1 铭牌说明	02
2.2 型号说明	02
2.3 齿轮箱的噪声水平	03
2.4 温升	06
2.5 注意事项	07
3 安装与拆卸	07
3.1 安装前的注意事项	07
3.2 准备工作	08
3.3 齿轮箱的整机安装	08
3.4 联轴器的安装	11
3.5 皮带轮或链轮的安装	12
3.6 齿轮箱空心轴的安装	13
3.7 齿轮箱空心轴的拆卸	14
3.8 附件的安装	15
3.9 最后的工作	15
4 安装说明	16
4.1 安装方位说明	16
4.2 安装方位图示	16
4.3 综合说明	16
5 润滑/冷却/加热	18
5.1 润滑	18
5.2 冷却	21
5.3 加热	23
5.4 逆止机构	23
6 使用	24
6.1 润滑油添加	24
6.2 设备检查	24
6.3 起动	24
7 检查与维护	25
7.1 定期检查与维护	25
7.2 检查与维护的周期	25
7.3 检查与维护的注意事项	25
8 故障处理	26
8.1 故障、原因和措施	26
售后服务	29

重要提示

在安装操作过程中，
请注意本手册中的安全提示和警告提示！



使用建议和有用的信息



有害情况：
可能产生的后果：损坏传动装置和环境



遵守本手册的规定可以让装置无故障运行，同时也满足质量缺陷索赔的要求，因此在使用传动装置进行工作之前，请您先阅读本手册；
本手册包含重要的安装维护提示，请将手册保管在靠近设备的位置，以便安装维护参阅。

1 安全说明

安全说明主要涉及齿轮箱的使用。当使用齿轮箱时，请注意手册中的相关安全提示！

使用手册为本公司所供齿轮箱的有机组成部分。

齿轮箱的安装、操作、维护和修理人员均需认真阅读本手册并遵守其中的规定。严格遵循手册中的规定是实现产品无故障运行和履行任何质量保证要求的必要条件。

在遵循手册规定的前提下还要注意：

- 相关安全和事故防范的国家（地区）规定；
- 相关设备的特别规定和要求；
- 设备装置上的安全警告和安全标志牌。

下列情况会导致人身伤害和财产损失：

- 使用不当；
- 安装或操作失误；
- 违反规定拆除必要的防护罩或机壳。

若因违反本手册的规定而造成的任何损伤或停机，本公司概不负责。

为不断追求技术进步，我们保留对其进行修改的权力。通过不断改进，将在保持基本特性的基础上，有利于进一步提高其使用性能和工作安全性。

2 技术说明

2.1 铭牌说明

⊕ BONENG ⊕			
Type			
n ₂		RPM	
P ₁	kW	T ₂	N · m
n ₁	RPM	i	
Oil		Wt.	kg
NO.		Date	
⊕ ⊕			

铭牌上的数据十分重要，请仔细阅读，并保持其整洁，当需要服务时，请提供铭牌上的产品编号、使用时间及故障类型。

- ① 产品型号 (前缀“M”代表CMAC认证)
- ② 输出转速 (直联电机时才有)
- ③ 额定输入功率 kW (直联电机时指电机功率)
- ④ 额定输出扭矩 N · m
- ⑤ 额定输入转速 RPM (直联电机时是指电机转速)
- ⑥ 公称减速比
- ⑦ 润滑油粘度
- ⑧ 重量
- ⑨ 产品编号
- ⑩ 出厂日期

2.2 型号说明

2.2.1 产品范围

H204~H226	B204~B218
H305~H326	B304~B326
H407~H426	B405~B426

型号表示方法：

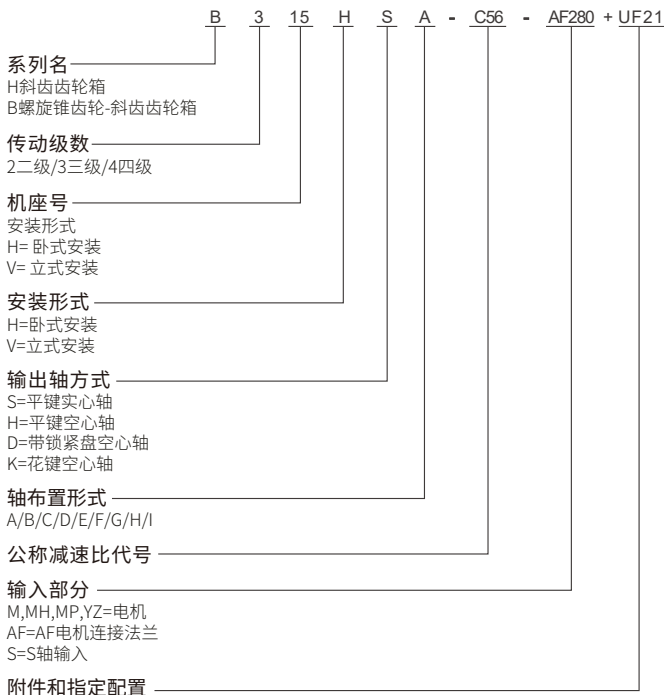

附件代号见选型样本

型号前带“M”表示产品拥有CMAC认证，如：MB307HSA-C45；
型号说明仅供用户参考使用，特殊供货类别敬请垂询。

2.3 齿轮箱的噪声水平

噪声符合相关的国家标准，行业标准及企业标准。

噪声的检测根据声强法进行，距声源处（所检测表面噪声区域）1 m的距离检测。

噪声水平是指齿轮箱在良好工况条件下正常运行，在标牌上规定的额定输入转速 n_1 、额定输入功率 P_1 条件下工作时，检测得到的噪声水平。如果给出不同的参数，则选择最高转速和最大功率值。

由于所采用的检测技术使重复测量无法得到最终结果，则应采用本公司试验台上得到的检测结果。

测量表面的噪声水平不包括润滑装置附件的噪声

2.3.1 无风扇的斜齿齿轮箱(H...)的噪音水平

无风扇的斜齿齿轮箱的测量表面噪声水平LPA,单位dB(A)																										
型号	公称 减速比	输入 转速	规格																							
			3	4	5	6	7	8	9	10	11	12	13	14	15	16	17	18	19	20	21	22	23	24	25	26
H2	6.3	1500	-	71	74	75	76	77	79	79	80	81	81	82	84	85	85	86	-	-	-	-	-	-	-	-
	-	1000	-	66	69	70	71	72	74	74	75	76	76	77	80	80	80	81	83	83	84	-	-	-	-	-
	10	750	-	63	66	67	67	69	70	71	72	73	73	74	76	77	77	78	80	80	81	81	81	-	-	-
	11.2	1500	-	69	72	73	74	75	77	77	78	79	79	80	82	83	83	84	-	-	-	-	-	-	-	-
	-	1000	-	64	67	68	69	70	72	72	73	74	74	75	77	78	78	79	81	81	82	82	83	83	-	-
	16	750	-	61	64	65	66	67	69	69	70	71	71	72	74	75	75	76	77	78	79	79	79	80	81	81
	18	1500	-	66	69	70	71	72	74	74	75	76	77	78	80	80	81	82	83	84	84	85	-	-	-	-
	-	1000	-	61	64	65	66	68	69	69	70	71	72	73	75	75	76	77	78	79	79	80	80	81	81	82
	28	750	-	1)	61	62	63	64	66	66	67	68	69	70	72	72	73	73	75	75	76	76	77	77	78	78
	H3	22.4	1500	-	-	68	69	73	74	74	75	77	77	78	79	81	81	82	83	83	84	85	86	86	87	-
-		1000	-	-	63	65	68	69	69	71	72	73	73	74	76	77	77	78	79	79	81	81	81	82	83	83
35.5		750	-	-	60	61	65	66	65	67	69	69	70	71	73	73	74	75	75	76	77	78	78	79	79	80
40		1500	-	-	65	67	70	71	71	73	74	75	76	76	78	79	79	80	81	81	83	83	84	84	-	-
-		1000	-	-	1)	62	65	66	66	68	69	70	71	72	73	74	75	75	76	77	78	78	79	79	80	80
63		750	-	-	1)	62	63	63	65	66	67	67	68	70	71	71	72	73	73	75	75	76	76	77	77	77
71		1500	-	-	62	64	67	68	68	70	71	72	73	74	76	76	77	78	78	79	80	81	81	82	82	83
-		1000	-	-	1)	62	63	63	65	66	67	68	69	71	71	72	73	73	74	75	76	76	77	77	78	78
112	750	-	-	1)	62	63	64	65	66	68	68	69	70	70	71	72	72	73	73	74	74	75	75	76	76	
H4	100	1500	-	-	-	66	67	68	69	70	71	72	73	75	75	76	76	77	78	78	78	79	80	81	81	
	-	1000	-	-	-	62	63	63	64	65	66	67	68	70	70	71	72	72	73	73	74	74	76	76	77	
	140	750	-	-	-	1)	61	62	63	64	65	66	67	68	69	69	70	70	71	71	72	73	73	74	74	
	160	1500	-	-	-	64	65	66	66	68	68	69	70	72	73	73	74	74	75	75	76	76	78	78	79	
	-	1000	-	-	-	1)	60	61	62	63	64	64	65	67	68	68	69	70	70	71	71	72	73	74	74	
	250	750	-	-	-	1)	61	62	63	64	65	66	67	69	70	70	71	72	72	73	73	74	75	76	76	
	280	1500	-	-	-	61	62	63	64	65	66	67	67	69	70	70	71	72	72	73	73	74	75	76	76	
	-	1000	-	-	-	1)	61	62	63	64	65	66	67	69	70	70	71	72	72	73	73	74	75	76	76	
	450	750	-	-	-	1)	61	62	63	64	65	66	67	69	70	70	71	72	72	73	73	74	75	76	76	

1)LPA < 60dB(A)

2.3.2 安装风扇的斜齿齿轮箱(H...)的噪音水平

配备了风扇的斜齿齿轮箱的测量表面噪声水平LPA,单位dB(A)																											
型号	公称 减速比	输入 转速	规格																								
			3	4	5	6	7	8	9	10	11	12	13	14	15	16	17	18	19	20	21	22	23	24	25	26	
H2	6.3	1500	-	75	76	77	80	81	82	84	85	86	88	90	92	94	96	96	-	-	-	-	-	-	-	-	
		1000	-	69	71	72	74	75	77	79	80	81	83	84	85	86	87	88	88	89	90	-	-	-	-	-	-
		750	-	66	68	69	70	72	73	75	76	77	79	80	81	82	83	83	84	84	85	85	86	-	-	-	-
	11.2	1500	-	73	75	77	79	80	81	82	85	88	90	91	92	93	95	95	-	-	-	-	-	-	-	-	-
		1000	-	68	69	70	72	73	75	77	79	80	82	83	84	85	85	86	86	87	87	87	88	88	-	-	-
		750	-	64	66	67	69	70	71	73	74	76	78	79	79	80	81	81	82	82	83	83	83	84	84	85	85
	18	1500	-	71	73	75	77	78	80	82	84	86	87	90	91	92	93	94	94	95	95	95	-	-	-	-	-
		1000	-	65	67	68	71	72	73	75	77	78	80	81	82	83	83	84	85	85	86	86	86	87	87	87	
		750	-	62	64	65	67	68	69	71	73	74	75	77	78	79	79	80	80	81	81	81	82	82	82	83	83
	H3	22.4	1500	-	-	71	72	75	75	77	77	80	80	81	81	84	84	84	85	-	-	-	-	-	-	-	-
			1000	-	-	65	66	69	70	71	72	74	75	75	75	78	78	78	79	-	-	-	-	-	-	-	-
			750	-	-	62	62	66	67	67	68	70	70	71	72	74	74	75	76	-	-	-	-	-	-	-	-
40		1500	-	-	70	71	73	74	76	76	79	79	80	80	83	82	83	83	-	-	-	-	-	-	-	-	
		1000	-	-	64	65	67	68	69	70	73	73	73	74	77	77	77	77	-	-	-	-	-	-	-	-	
		750	-	-	62	62	63	64	65	66	69	69	69	70	72	73	73	73	-	-	-	-	-	-	-	-	
71		1500	-	-	70	70	72	72	75	75	78	78	78	78	82	82	82	82	-	-	-	-	-	-	-	-	
		1000	-	-	64	64	65	66	68	69	71	72	72	72	75	75	75	76	-	-	-	-	-	-	-	-	
		750	-	-	61	61	62	62	64	65	67	67	68	68	71	71	71	72	-	-	-	-	-	-	-	-	

2.3.3 无风扇的锥齿-斜齿齿轮箱(B...)的噪音水平

无风扇的锥齿-斜齿齿轮箱的测量表面噪声水平LPA,单位dB(A)																												
型号	公称 减速比	输入 转速	规格																									
			3	4	5	6	7	8	9	10	11	12	13	14	15	16	17	18	19	20	21	22	23	24	25	26		
B2	5	1500	72	75	78	80	82	83	84	86	87	88	89	90	93	-	-	-	-	-	-	-	-	-	-	-		
		1000	66	70	72	73	76	77	78	79	81	82	83	84	86	88	89	-	-	-	-	-	-	-	-	-	-	
		750	1)	63	65	66	69	71	72	73	74	75	77	78	80	82	83	84	-	-	-	-	-	-	-	-	-	-
	9	1500	67	71	74	75	77	79	80	81	83	84	85	86	87	89	-	-	-	-	-	-	-	-	-	-	-	-
		1000	61	65	67	69	72	73	74	76	77	78	80	81	82	83	85	86	-	-	-	-	-	-	-	-	-	-
		750	1)	1)	60	63	65	66	67	69	71	72	73	74	76	77	78	79	-	-	-	-	-	-	-	-	-	-
	14	1500	63	66	69	71	72	74	75	77	78	80	81	82	85	85	-	-	-	-	-	-	-	-	-	-	-	-
		1000	1)	61	63	65	67	68	69	71	72	74	75	77	79	80	81	81	-	-	-	-	-	-	-	-	-	-
		750	1)	1)	1)	1)	60	62	63	64	66	67	68	70	72	73	74	75	-	-	-	-	-	-	-	-	-	-
22.4	1500	63	66	69	71	72	74	75	77	78	80	81	82	85	85	-	-	-	-	-	-	-	-	-	-	-	-	
	1000	1)	61	63	65	67	68	69	71	72	74	75	77	79	80	81	81	-	-	-	-	-	-	-	-	-	-	
	750	1)	1)	1)	1)	60	62	63	64	66	67	68	70	72	73	74	75	-	-	-	-	-	-	-	-	-	-	
B3	12.5	1500	65	68	71	74	75	76	77	79	81	83	84	85	86	87	87	88	89	90	91	92	-	-	-	-	-	
		1000	1)	63	66	68	69	70	72	73	75	77	78	80	80	81	82	82	84	85	86	86	88	88	89	90	-	
		750	1)	1)	1)	61	62	64	65	66	68	71	71	73	73	74	75	75	77	78	79	79	81	82	83	84	84	
	35.5	1500	60	65	67	70	71	71	72	74	77	79	80	81	82	83	83	84	86	86	88	88	-	-	-	-	-	
		1000	1)	1)	62	65	65	66	66	69	71	73	75	76	76	77	77	78	80	81	82	83	84	85	86	87	87	
		750	1)	1)	1)	1)	1)	1)	1)	62	65	67	68	69	70	70	71	72	74	74	75	76	78	80	80	80	80	
	63	1500	1)	61	64	70	67	68	68	70	73	75	76	78	78	79	79	80	82	83	84	84	-	-	-	-	-	
		1000	1)	1)	1)	63	62	62	62	65	68	70	71	72	73	73	74	75	76	77	78	79	81	81	83	83		
		750	1)	1)	1)	1)	1)	1)	1)	1)	61	63	64	65	66	67	67	68	70	70	72	72	74	75	76	76	76	
B4	80	1500	-	-	64	65	67	68	70	72	75	76	77	79	80	81	82	83	84	85	86	86	87	88	87	89		
		1000	-	-	1)	1)	61	63	64	67	69	70	72	73	74	75	76	77	78	79	80	80	81	82	82	83		
		750	-	-	1)	1)	1)	1)	1)	1)	62	64	65	66	68	68	69	71	71	72	73	74	74	75	75	76		
	140	1500	-	-	60	61	63	65	66	68	71	72	73	75	76	77	78	79	80	81	82	82	83	84	85	86		
		1000	-	-	1)	1)	1)	1)	61	63	65	67	68	69	71	71	72	74	75	75	76	77	78	78	79	80		
		750	-	-	1)	1)	1)	1)	1)	1)	1)	1)	1)	1)	61	62	64	65	66	67	68	69	69	70	71	72	73	73
	250	1500	-	-	1)	1)	1)	62	63	65	67	69	70	71	73	73	75	76	77	77	78	79	80	80	81	82		
		1000	-	-	1)	1)	1)	1)	1)	1)	62	63	64	66	67	68	69	70	71	72	73	73	74	75	76	77		
		750	-	-	1)	1)	1)	1)	1)	1)	1)	1)	1)	1)	1)	1)	61	62	63	64	65	66	66	67	68	69	70	
400	1500	-	-	1)	1)	1)	1)	1)	1)	1)	1)	1)	1)	1)	1)	61	62	63	64	65	66	66	67	68	69	70		
	1000	-	-	1)	1)	1)	1)	1)	1)	1)	1)	1)	1)	1)	1)	61	62	63	64	65	66	66	67	68	69	70		
	750	-	-	1)	1)	1)	1)	1)	1)	1)	1)	1)	1)	1)	1)	61	62	63	64	65	66	66	67	68	69	70		

1)LPA < 60dB(A)

2.3.4 安装风扇的锥齿-斜齿齿轮箱(B...)的噪音水平

配备了风扇的锥齿-斜齿齿轮箱的测量表面噪声水平LPA,单位dB(A)																													
型号	公称 减速比	输入 转速	规格																										
			3	4	5	6	7	8	9	10	11	12	13	14	15	16	17	18	19	20	20	22	23	24	25	26			
B2	5	1500	73	76	79	81	83	84	85	87	88	89	91	92	94	-	-	-	-	-	-	-	-	-	-	-	-		
		1000	67	71	73	74	77	78	79	80	82	82	84	85	87	89	90	-	-	-	-	-	-	-	-	-	-	-	
		750	61	64	66	67	70	71	72	73	75	76	77	78	81	82	83	85	-	-	-	-	-	-	-	-	-	-	-
	9	1500	70	73	75	76	78	81	82	83	84	85	86	87	88	90	-	-	-	-	-	-	-	-	-	-	-	-	-
		1000	63	67	68	70	73	74	75	77	79	80	81	82	83	84	86	87	-	-	-	-	-	-	-	-	-	-	-
		750	1)	61	62	64	66	67	68	70	72	73	74	75	77	78	79	80	-	-	-	-	-	-	-	-	-	-	-
	14	1500	67	71	74	76	78	79	80	81	83	84	87	88	89	90	-	-	-	-	-	-	-	-	-	-	-	-	-
		1000	60	64	67	68	70	72	73	74	78	79	80	81	82	83	84	84	-	-	-	-	-	-	-	-	-	-	-
		750	1)	1)	61	63	65	67	68	69	71	72	73	73	74	74	75	76	-	-	-	-	-	-	-	-	-	-	-
	6	1500	67	71	74	76	78	79	80	81	83	84	87	88	89	90	-	-	-	-	-	-	-	-	-	-	-	-	-
		1000	60	64	67	68	70	72	73	74	78	79	80	81	82	83	84	84	-	-	-	-	-	-	-	-	-	-	-
		750	1)	1)	61	63	65	67	68	69	71	72	73	73	74	74	75	76	-	-	-	-	-	-	-	-	-	-	-
B3	12.5	1500	69	72	75	77	79	80	81	82	83	85	88	89	90	91	93	93	93	93	95	95	-	-	-	-	-	-	
		1000	62	65	68	69	71	72	73	74	77	78	80	82	83	83	84	85	86	86	88	88	89	90	91	-	-	-	
		750	1)	1)	63	64	66	68	69	70	71	73	74	75	76	77	78	78	79	79	81	81	82	84	85	85	-	-	-
	31.5	1500	67	69	72	73	74	75	77	79	82	84	86	87	88	89	90	91	92	92	93	93	-	-	-	-	-	-	-
		1000	1)	63	65	66	67	69	71	72	73	75	77	78	79	80	81	82	83	83	85	86	86	87	88	89	-	-	-
		750	1)	1)	1)	1)	62	64	65	67	69	70	71	72	73	74	75	76	77	77	79	79	80	81	82	82	-	-	-
	56	1500	66	68	70	71	73	74	75	78	81	83	85	86	87	88	89	90	91	91	92	92	-	-	-	-	-	-	-
		1000	1)	61	63	64	66	68	69	71	73	75	77	78	79	80	71	81	82	82	83	84	84	84	85	86	86	-	-
		750	1)	1)	1)	1)	61	63	64	66	67	68	70	71	72	73	74	74	75	75	77	77	78	79	79	80	-	-	-
	63	1500	66	68	70	71	73	74	75	78	81	83	85	86	87	88	89	90	91	91	92	92	-	-	-	-	-	-	-
		1000	1)	61	63	64	66	68	69	71	73	75	77	78	79	80	71	81	82	82	83	84	84	84	85	86	86	-	-
		750	1)	1)	1)	1)	61	63	64	66	67	68	70	71	72	73	74	74	75	75	77	77	78	79	79	80	-	-	-
90	1500	66	68	70	71	73	74	75	78	81	83	85	86	87	88	89	90	91	91	92	92	-	-	-	-	-	-	-	
	1000	1)	61	63	64	66	68	69	71	73	75	77	78	79	80	71	81	82	82	83	84	84	84	85	86	86	-	-	
	750	1)	1)	1)	1)	61	63	64	66	67	68	70	71	72	73	74	74	75	75	77	77	78	79	79	80	-	-	-	

1)LPA < 60dB(A)

2.4 温升

齿轮箱运转时产生的温升环境温度为40 时，油池最高温度不超过85 。

齿轮箱运转时允许的润滑油温度范围大致如下：

矿物油约 -10 ~ +90 （瞬间+100 ）

合成油约 -20 ~ +100 （瞬间+110 ）

2.5 注意事项 (下述注意事项与齿轮箱的使用有关)

在户外安装时应避免阳光直射，一定要避免热力集中影响齿轮箱的正常性能。

一定不能用高压清理设备清洁齿轮箱。

对齿轮箱所进行检修、保养、维护、安装都必须在齿轮箱不工作的情况下进行。

在齿轮箱上不得进行焊接工作，也不得用作焊接工作的接地点。焊接会造成精密齿轮和轴承不可修复的损坏。

如果在齿轮箱的运行过程中发现了任何异常现象（例如过热或者不正常的噪声等），应该立即关断驱动装置。

凡是旋转的零部件必须配备合适的防护罩以防止人员的意外接触，例如联轴器、液力耦合器、齿轮、驱动皮带轮等。

一定要遵守齿轮箱上所附加的说明，例如铭牌、指示方向的箭头等。这些铭牌和标记上面不得有灰尘和油漆。

在组装或者拆卸工作中损坏了的螺栓一定要用同等强度和类型的新螺栓更换。

本公司对不合理使用联轴器、私自对齿轮箱进行修改，以及使用非本公司零部件的情况，所造成的不良后果不在‘三包’服务之内。

根据齿轮箱的操作条件，齿轮箱的表面、润滑油和零部件可能会达到相当高的温度，小心烫伤！当更换润滑油的时候，要谨慎小心，不要被热油烫伤。

齿轮箱应该放置在不振动的干燥木制基座上并遮盖好。当储存齿轮箱和任何单独零部件的时候一定要做好防锈措施，以免生锈，储存时不得将齿轮箱叠放在一起。

除订货合同中另外有所规定，否则齿轮箱不得储存或工作在强酸、强碱、低温、高温和重度的空气污染、潮湿以及具有化学物品的场所。

在搬运齿轮箱时，一定要特别小心，防止轴端被撞击，因为这样将有可能造成齿轮箱的损坏。在吊运齿轮箱时，不得将吊环螺钉安装在轴端处的螺纹上。

配件一定要从BONENG公司购买。

3 安装与拆卸

3.1 安装前的注意事项



- 确认齿轮箱完好无损（在运输或储存过程中未损坏）；
- 确认现场环境条件与铭牌内容相符；
- 标准齿轮箱使用环境温度：-20 ~+50 ；无油、酸、有害气体、蒸汽、放射性物质等；
- 若齿轮箱储存时间在一年以上，轴承内润滑剂的使用寿命将缩短；



- 在户外安装时应该避免阳光直射，一定要避免热力集中影响齿轮箱的正常性能；
- 特殊形式齿轮箱：是根据环境条件配置的；
- 在进行规划阶段就应该预留足够的空间进行维护保养和修理工作；
- 配备了风扇的齿轮箱，应该有足够的空间以便能够吸入空气。

3.2 准备工作

彻底清除输出输入轴和法兰表面的防腐剂、污物等；注意不要让溶剂浸入并损坏油封；
工具/材料的准备：一组扳手、扭矩扳手、装配夹具、输入和输出紧固装置、润滑剂(防锈油)、密封螺栓的介质(螺纹锁固剂)。

3.3 齿轮箱的整机安装

基础

准备刚性好的基础或牢固的台架来安装传动设备，同时也需充分考虑即使加上最大载荷也不至于改变装配好后各部件的位置。

齿轮箱的基础应该水平并平整。基础的设计应该保证不会产生谐振并且不会有临近的基础传递过来的振动。

安装齿轮箱的基础的刚性应该可靠，适合于齿轮箱的重量和扭矩，并且要考虑作用在齿轮箱上的力。

底脚安装六角头螺栓和螺母应该紧固到规定的扭矩。我们推荐强度级别为8.8或者更高强度的螺栓。

吊装位置

对于未安装附件的齿轮箱，
应采用齿轮箱上的四个孔起吊。

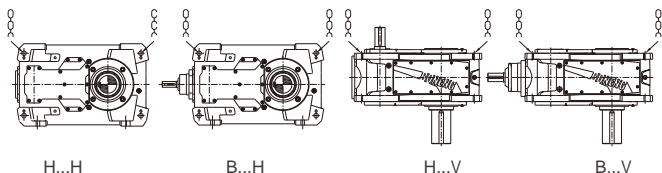

对于安装了其他附件（比如电机或者安装底座）的齿轮箱，
应当增加起吊点：

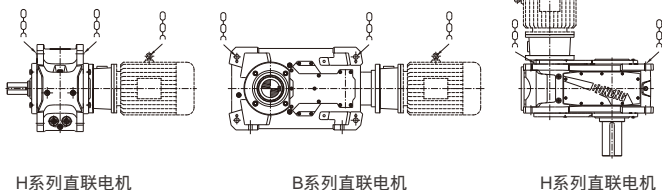

H系列直联电机

B系列直联电机

H系列直联电机

⚠ 注：禁止使用轴端螺纹安装吊环后做为起吊点。

齿轮箱的整机安装步骤

首先要使初始对中表面（图示位置）对中；

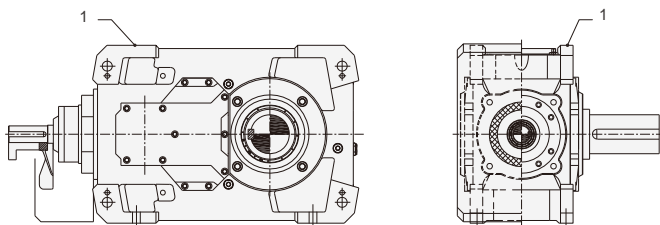

1 初始对中表面

然后要保证输入端与输出端的轴线精密对中，此过程一定要细致进行。一般可采用以下一些方法：

· 直尺 · 气泡水平仪 · 千分表 · 塞尺等；

对中好后就可以将齿轮箱固定了，然后再次检查对中情况。

说明：对中的精密程度乃是决定轴、轴承、联轴器使用寿命的一个非常重要的因数，应尽量保证对中的公差为零。

根据不同安装形式还需注意：

底座式安装时应校准中心高，联轴器联接时应校准两轴的同轴度；柔性联轴器时浮动量不超过联轴器的允许范围，刚性联接时保证各安装联接的形位公差；长轴联接还要考虑轴的足够刚度。

法兰式安装时，凸肩（或凹肩）应配合良好，以免错位。法兰式安装并配空心轴联接时，特别应保证联接的形位公差。

扭力臂安装时，空心轴与被驱动设备的驱动轴应配合良好，被驱动设备的驱动轴的浮动或设备振动应小于弹性块允许的范围，力臂应固定并锁紧。扭力臂应安装在齿轮箱侧面，并保证不受应力，如图所示：

实心输出轴加装联轴器、皮带轮、齿轮、链轮等时，请勿重击，应用输出轴外端螺孔，压入连接件。皮带轮、链轮、搅拌式还需考虑径向力。

安装在齿轮箱上的扭力臂

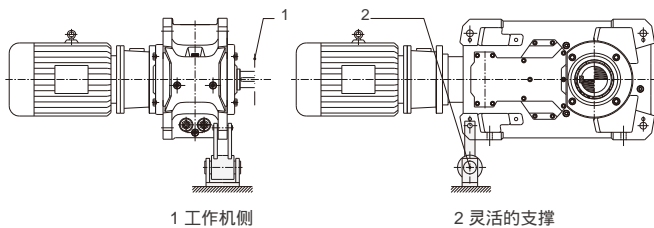

1 工作机侧

2 灵活的支撑

安装在齿轮箱底座上的扭力臂

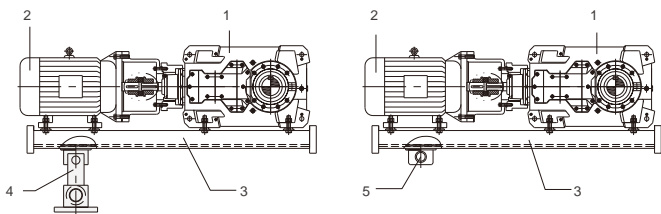

1 齿轮箱
2 电机
3 底座

4 扭力臂
5 力臂支撑

3.4 联轴器的安装

齿轮箱的输入端的驱动装置应该采用弹性联轴器或者液力耦合器。

当齿轮箱的输出轴是实心轴的时候，同样也应该使用弹性联轴器。

如果要使用刚性联轴器或者其它会产生额外的径向力或轴向力的输入和输出零部件的话（例如齿轮、皮带轮、飞轮、液力耦合器等），都应该在合同中注明。

输入轴与驱动轴安装联接时，必须保证输入轴和驱动轴同轴心。同轴度误差大会增大机械振动，导致轴承过早破坏并且影响齿轮接触。

如果联轴器副包含螺纹销，在旋入之前，必须给螺纹销涂抹厌氧型螺纹锁固密封剂（例如乐泰243或天山1243）。

如下图所示，输入轴与驱动轴通过联轴器安装后，必须用表找正，有关检测参数推荐满足下表《同轴精度表》要求后，设备方可生产运行。

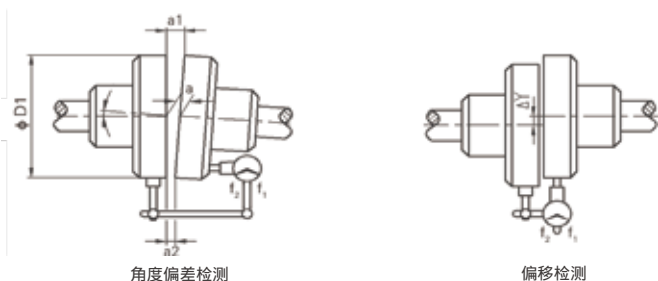

同轴精度表

外径D	n<500r/min		500 ~ 1500r/min		>1500r/min	
	a1 - a2	Y	a1 - a2	Y	a1 - a2	Y
D 100	0.05	0.05	0.04	0.04	0.03	0.03
100<D 200	0.06	0.06	0.05	0.05	0.04	0.04
200<D 400	0.12	0.10	0.10	0.08	0.08	0.06
400<D 800	0.20	0.16	0.16	0.12	0.12	0.10



说明：

当联轴器外径的圆周速度在30m/s及以下时，一定要进行静平衡。当外径圆周速度超过30m/s 时就要进行动平衡。

3.5 皮带轮或链轮的安装

齿轮箱的输入轴和输出轴加装皮带轮或链轮时，必须使皮带轮或者链轮传力部位尽量靠近轴肩。

如下图所示：

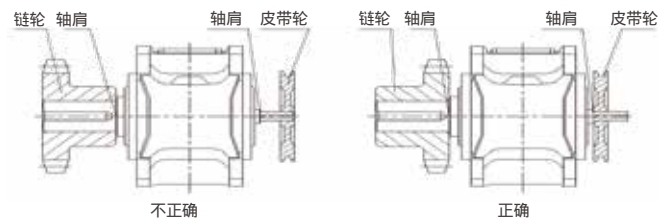

皮带轮或链轮安装时，应保证输入轴和驱动装置精密对中，保证图示位置的四个对中点最大轴向变动允差值为每1000mm变动1mm。

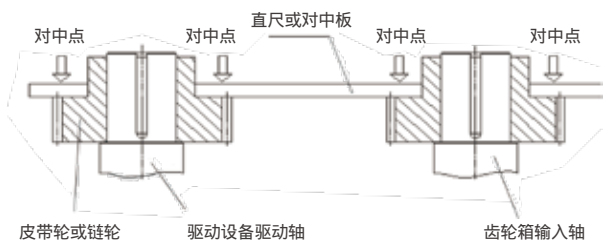

皮带轮或链轮安装时，应保证皮带和链条有一定的张紧力。

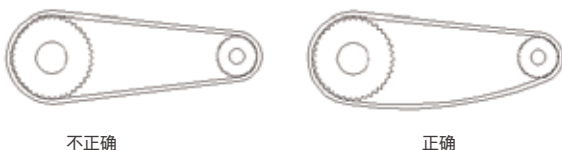

3.6 齿轮箱空心轴的安装

齿轮箱空心轴与被驱动设备的实心轴连接时,应清理干净并涂防锈油(空心轴一定要精密对中)。除了在图中所示的螺母和螺杆的方法安装以外,还可以使用其它类型的装置安装,例如液压提升装置等。

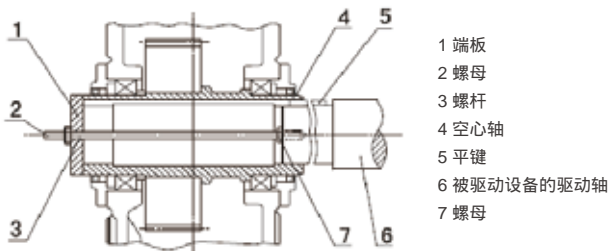

当齿轮箱空心轴配置锁紧盘时,应先在空心轴上套上锁紧盘,再按上述方法完成被驱动设备的驱动轴的安装,在安装被驱动设备的驱动轴之前不要拧紧锁紧盘上的紧固螺栓。



所供货的锁紧盘是可直接安装的,在首次受力之前一定不能拆卸下来。

安装锁紧盘前,要确保空心轴孔和被驱动设备的驱动轴在锁紧盘区域不能有润滑油。

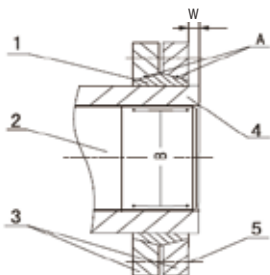

- 1 内环
- 2 被驱动设备的驱动轴
- 3 外环
- 4 空心轴
- 5 紧固螺栓
- A 有润滑脂的部位
- B 绝对不能有润滑脂的部位
- W 安装宽度

拧紧锁紧盘上的螺栓时,严禁按相邻顺序逐个拧紧,应按锁紧盘安装要求,按等边三角形顺序逐次拧紧紧固螺栓,每次循环拧紧过程中,每个螺栓只能拧紧螺丝的1/4圈。

安装螺栓一般情况下采用8.8级,如果有高温或者振动冲击等情况,请在螺纹连接处作好防松措施。各个紧固螺栓的拧紧扭矩见下表:

螺栓大小 (mm)	预紧力矩 (N·m)	螺栓大小 (mm)	预紧力矩 (N·m)
M6	15	M30	2000
M8	36	M36	3560
M10	72	M42	5720
M12	123	M48	8640
M16	295	M56	13850
M20	580	M64	14300
M24	1000	M72	20800

3.7 齿轮箱空心轴的拆卸

空心轴的拆卸

根据现场实际上可以使用的设备，可以用在端板上的螺杆、中心螺杆或者液压提升装置将齿轮箱从被驱动设备的驱动轴上脱下来。空心轴的每个端面都配备了2个螺丝孔可以拧入固定端板的螺栓。

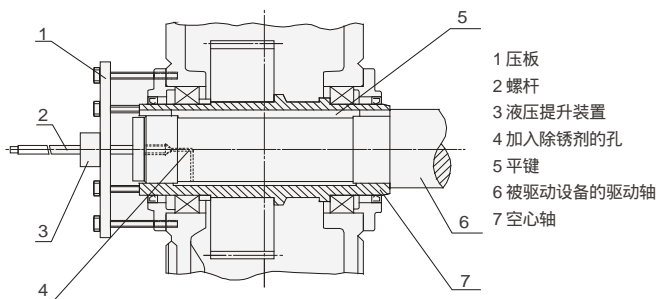

注：辅助板不在供货范围内。

(空心轴端螺纹孔的分布和大小请参照BONENG公司技术图纸)

配置了锁紧盘的齿轮箱空心轴拆卸时，锁紧盘松开的过程与紧固的方向相反，拆掉锁紧盘后再按上述方法完成被驱动设备驱动轴的拆卸。

拆卸锁紧盘时应注意：



拆卸时严禁按照相邻的顺序松开螺栓。

锁紧盘外环与内环不能分离时，可将几个螺栓拧入拆卸螺丝，将内环和外环分开。

3.8 附件的安装

所涉及的附件的技术数据可参见具体订单的设备清单。

电气和控制设备应该按照设备供应商的说明书进行。

操作和维修应该按照根据订单提供操作说明书中的规定进行

配备了冷却盘管的齿轮箱

在连接冷却水的冷却盘管之前要先将堵头从冷却盘管的连接接头上取下来并彻底冲洗螺旋管将脏物清理干净。

安装冷却水的进水和出水管，进出水口压力不能大于0.8MPa。

配备了水冷却润滑油装置的齿轮箱

在连接水冷却润滑油装置之前要将水管上的堵头取下来并彻底冲洗干净。

安装冷却水的入口和出口管路。水流的方向和接头的位置敬请垂询。

电气连接压力监测装置。

配备了加热装置的齿轮箱

电气连接温度监测装置。

电气连接加热元件。

配备了油温测量装置的齿轮箱

电气连接电阻式温度计和显示仪表（应该由用户自备）。

配备了油面高度监测装置的齿轮箱

电气连接油面高度监测装置。

配备了转速发送器的齿轮箱

电气连接转速发送器。

3.9 最后的工作

在安装了齿轮箱后要检查所有的螺丝接头的密封性。

还要在将紧固件拧紧后检查对中是否发生了变化。

对照具体订单的设备清单和所附之图纸检查有可能拆掉的装置是否已经全部安装。

4 安装说明

4.1 H&B安装方位说明

齿轮箱具体的安装方位及选型可参见BONENG公司工业齿轮箱选型手册(H&B系列)。

4.2 H&B安装方位图示

齿轮箱的安装方位页面中使用的图形符号及其含义：

图形符号		含义	
		通气帽	进油孔
		油尺	油镜
		放油孔	

4.3 综合说明

箱体上配备了尺寸合适的起吊螺纹孔、检查和组装盖。齿轮箱箱体里面润滑油的液面高度可用观察油尺或者观察油镜进行检查。在箱体上配备了油尺、油塞、油镜和一个通气帽。

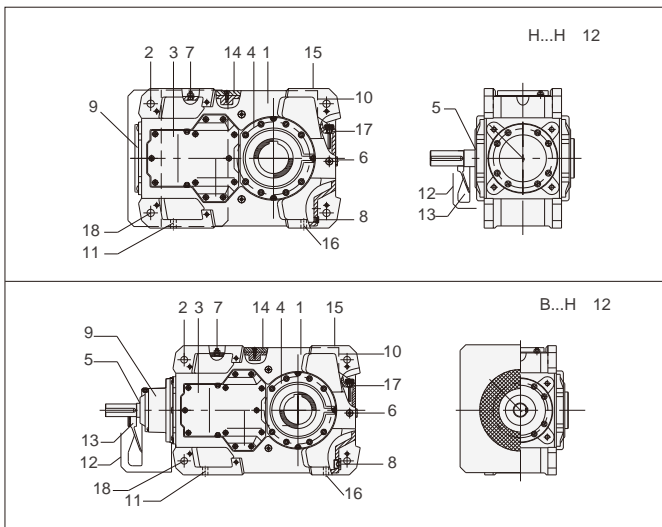

- | | |
|----------|------------|
| 1 箱体 | 10 铭牌 |
| 2 起吊螺纹孔 | 11 齿轮箱紧固件 |
| 3 盖 | 12 风扇罩 |
| 4 盖 | 13 风扇 |
| 5 油封 | 14 检查或者组装盖 |
| 6 油镜 | 15 对中线 |
| 7 /通气帽 | 16 螺纹基准线 |
| 8 油塞 | 17 加油口/油尺 |
| 9 盖或者轴承座 | 18 扭力臂的固定件 |

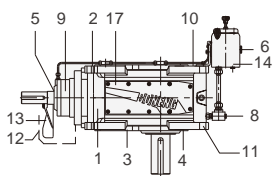

B...V 12(补偿油箱)

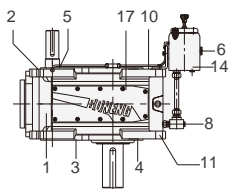
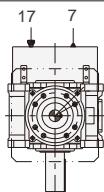

H...V 12(补偿油箱)

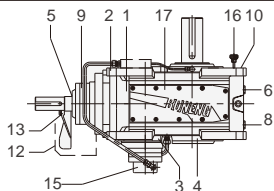
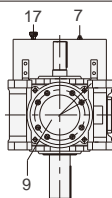

B...V 12(轴端油泵)

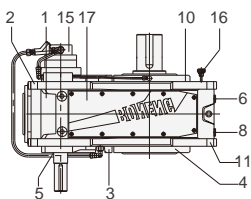
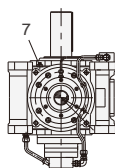

H...V 12(轴端油泵)

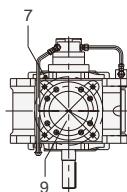

- 1 箱体
- 2 起吊螺纹孔
- 3 盖
- 4 盖
- 5 油封
- 6 油镜

- 7 通气帽
- 8 油塞
- 9 盖或轴承座
- 10 铭牌
- 11 齿轮箱紧固件
- 12 风扇罩

- 13 风扇
- 14 附加油箱
- 15 轴端油泵
- 16 加油口/油尺
- 17 检查或者组装盖

5 润滑/冷却/加热

5.1 润滑

润滑油的选择：

在相同粘度等级和类型的前提下，您可以自由地选择国际知名品牌的润滑油。如需改变推荐的粘度等级敬请垂询。

下表列出了产品规格对应使用润滑油牌号及使用环境温度。

环境温度	-20 ~ +40
粘度牌号	VG320



环境温度低于 -10 时必须使用合成油。

为确保产品的使用寿命，实际使用中推荐使用合成油。

使用环境温度超过上述范围时，请咨询BONENG公司技术部门。

润滑油的注油量

本注油量为建议值。根据齿轮箱级数和速比的不同，相应加油量也不同。请注意油尺刻度或油镜位作为加油量多少的指示。

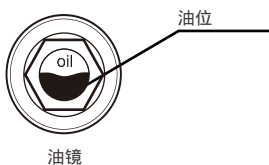
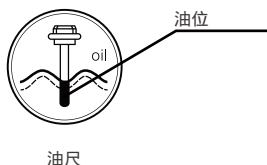

对于未设置或未安装油尺的产品类型，添加油量以产品样本说明为参考。

同一型号产品不同安装方位状态下，添加的油量也不相同。

下表列出了各系列对于不同安装方位相应的润滑油注油量建议值。

油量表 (L)																		
机座号	H2..H	H3..H	H4..H	B2..H	B3..H	B4..H	H2..V		H3..V		H3..V		B2..V		B3..V		B3..V	
3	—	—	—	—	—	—	—	—	—	—	—	—	—	—	—	—	—	—
4	10	—	—	10	9	—	25	—	—	—	—	—	28	—	28	—	—	—
5	15	15	—	16	14	16	23	10	35	13	—	—	41	20	32	12	36	15
6	16	17	—	19	15	18	27	11	37	15	—	—	50	23	35	13	40	16
7	27	28	25	31	25	30	58	22	60	25	50	20	75	35	52	22	60	30
8	30	30	27	34	28	33	62	25	72	30	60	25	90	38	67	28	70	35
9	42	45	48	48	40	48	100	42	100	40	95	38	115	53	115	48	110	60
10	45	46	50	50	42	50	110	46	110	45	110	45	135	60	125	52	130	67
11	71	85	80	80	66	80	160	60	170	66	165	65	190	86	180	75	180	75
12	76	90	87	95	72	90	180	70	190	75	180	75	215	95	200	85	195	85
13	135	160	130	140	130	145	—	80	—	115	—	95	—	100	—	95	—	130
14	140	165	140	155	140	150	—	90	—	126	—	105	—	110	—	110	—	150
15	210	235	230	220	210	230	—	140	—	180	—	150	—	145	—	165	—	200
16	215	245	235	230	220	235	—	150	—	190	—	160	—	160	—	190	—	235
17	290	305	290	320	290	295	—	175	—	190	—	190	—	210	—	210	—	215
18	300	315	305	335	300	305	—	185	—	200	—	200	—	220	—	240	—	250
19	320	420	360	—	380	480	—	—	—	—	—	—	—	—	—	—	—	—
20	340	450	380	—	440	550	—	—	—	—	—	—	—	—	—	—	—	—
21	370	500	440	—	460	600	—	—	—	—	—	—	—	—	—	—	—	—
22	400	560	480	—	490	650	—	—	—	—	—	—	—	—	—	—	—	—
23	430	620	520	—	530	710	—	—	—	—	—	—	—	—	—	—	—	—
24	450	650	550	—	600	810	—	—	—	—	—	—	—	—	—	—	—	—
25	760	735	880	—	640	1000	—	—	—	—	—	—	—	—	—	—	—	—
26	680	935	780	—	880	1150	—	—	—	—	—	—	—	—	—	—	—	—

油池飞溅润滑； 浸油润滑； 强制润滑 以上数据为平均值

润滑方式

浸油润滑:

当以垂直方式安装齿轮箱的时候,所有的轮齿和轴承都是浸没在润滑油里面的。当温度升高润滑油膨胀的时候所需之空间是靠螺栓和齿轮箱体连接在一起的润滑油附加油箱提供的。

飞溅润滑:

当以水平方式安装齿轮箱的时候,所有轮齿和轴承都是由齿轮带起来的润滑油进行润滑的。

非水平安装的齿轮箱上、轴承的转速和轮齿的圆周速度高时,飞溅润滑系统就要更换成压力润滑系统或者采用辅助的压力润滑系统。

通过附加装置实现的润滑系统:

当轴承或者齿轮线速度过高的时候,飞溅润滑就必须更换强制润滑方式,强制润滑系统包括轴端泵或电机油泵、过滤器和管路系统,轴端泵的进油、出油的孔位与齿轮箱的运行方向无关。

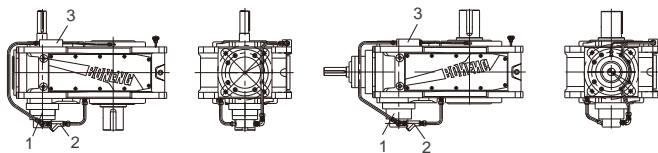

H...V 12(轴端泵)

1 轴端泵 2 过滤器 3 分油装置

B...V 12(轴端泵)

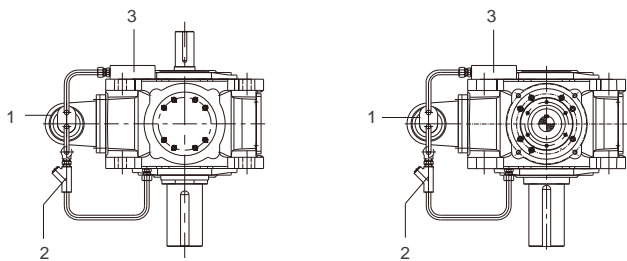

1 电机油泵 2 过滤器 3 分油装置

⚠ 注意: 配备了电机油泵的齿轮箱在启动时必须首先启动润滑油泵电机。

5.2 冷却

风扇

风扇是安装在齿轮箱的一根高速轴上的并有防护罩保护不会被接触到。该风扇从防护盖上的格栅吸入空气并将之吹到齿轮箱的箱体侧面的空气通道里面，这样就可以将齿轮箱箱体里面的部分热量散失掉。

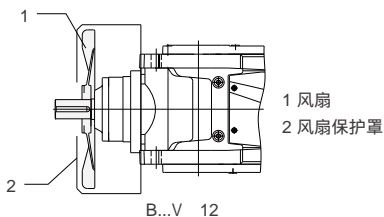

说明：

对于安装了风扇的齿轮箱，在安装联轴器或者其它零部件的时候一定要留出足够的空间让空气进入。所留出空间的正确尺寸示于齿轮箱文件中的尺寸图中。注意风扇的清洁，如果风扇或者齿轮箱的箱体脏了，就会降低其冷却效果。

冷却盘管冷却

冷却盘管的位置在齿轮箱的油箱里面。在冷却螺旋管里面通的是冷却水，冷却水要由用户自行提供。不论是自来水、海水还是半咸水都可以用于冷却。当冷却水流过冷却螺旋管的时候，热量就会从冷却螺旋管传递到冷却水中，从而将热量从系统中排出。

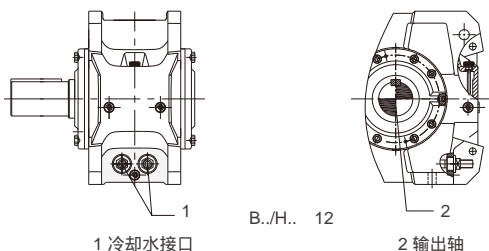

所需冷却水的流量 (l/min)

型号	规格																	
	3	4	5	6	7	8	9	10	11	12	13	14	15	16	17	18	19	20~26
H2.HB3.H	-	4	4	4	4	4	8	8	8	8	8	8	8	8	8	8	敬请垂询	敬请垂询
H3.H	-	-	4	4	4	4	4	4	8	8	8	8	8	8	8			
B2.H	-	4	8	4	8	4	8	8	8	8	8	8	8	8	8			
B4.HH4.H	-	-	4	4	4	4	4	4	8	8	8	8	8	8	8			

型号	规格																
	4	5	6	7	8	9	10	11	12	13	14	15	16	17	18	19~26	
H2.V/B3.V	4	4	4	4	4	8	8	8	8	8	8	8	8	8	8	敬请垂询	
H3.V	-	4	4	4	4	4	4	8	8	8	8	8	8	8			
B2.V	4	8	4	8	4	8	8	8	8	8	8	8	8	8			
B4.V/H4.V	-	4	4	4	4	4	4	8	8	8	8	8	8	8			

**注意：**

冷却水可以任意方向流过齿轮箱。冷却水的压力不得超过0.8MPa。如果将齿轮箱停放而且停放的时间比较长，或者如果有结冰的危险，就一定要将冷却水排放干净。要用压缩空气将水分吹干。

冷却螺旋管的末端一定不要扭曲，否则就会将螺旋管损坏。锁紧螺丝一定不能拧紧也不能拆卸下来，否则就会造成冷却螺旋管的损坏。

冷却装置冷却

带冷却装置冷却的齿轮箱是通过润滑油冷却，从而达到散热效果。常见冷却装置有下面两种：空气冷却装置和水冷却装置，如图所示：

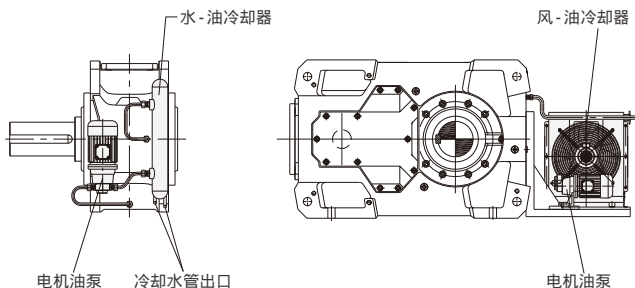

空气冷却装置采用的方法是利用周围环境的空气进行冷却，根据其流量不同，润滑油从一个通道或者几个通道流过冷却装置，而空气则由风扇吹过这些通道，达到冷却效果。



说明：配备了空气冷却装置的齿轮箱，一定要保证不能妨碍空气的循环，和临近的零部件以及和墙壁之间的最小距离参见齿轮箱文件中的图纸。

水冷却装置原理同空气冷却装置，只是冷却介质由空气换成水。为了保证最佳的冷却效果，一定要遵守所规定的冷却装置中的流动方向。冷却水入口和出口不能相反。冷却水压力不要超过0.8MPa，如果齿轮箱停止工作的时间比较长，或者水有结冰的危险，那么一定要将冷却水排放干净。要用压缩空气将水分吹干。

5.3 加热

在低温环境下，有可能要求在起动齿轮箱的驱动装置之前将齿轮箱箱体里面的润滑油加热，有时甚至在齿轮箱工作的过程中也要求加热其润滑油。在这些情况下就要配备一个或者两个加热元件。这些加热元件将电能转换成热能使得润滑油加热。加热元件是安放在保护套管里面放入齿轮箱的箱体的，所以在更换加热元件的时候就没有必要将齿轮箱箱体里面的润滑油排放出来。

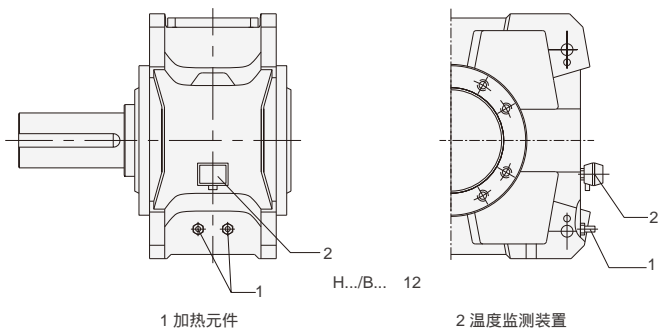

注意：

加热元件完全没入润滑油时才能接通加热元件的电源，否则会有极大的火灾危险！如果是在以后才安装加热元件的话，加热元件表面的最大加热能力不得超过 $0.8\text{W}/\text{cm}^2$ 。

5.4 逆止机构

某些使用场合要求齿轮箱配备机械式止回机构。这可以让齿轮箱在运行的过程中只能朝向一个方向旋转，而旋转的方向是用箭头在齿轮箱的输入和输出端标记出来的。止回机构是安装在齿轮箱的安装法兰盘上的并且是密封不漏油的，它和润滑油循环系统形成一个整体。

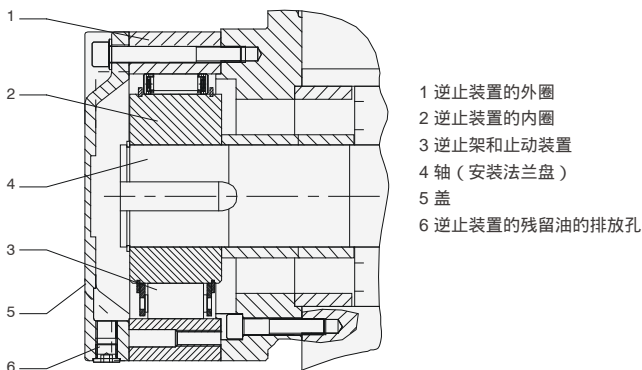

注意：

为了避免损坏止回装置或者齿轮箱，电机不得朝向禁止转动的方向旋转，注意齿轮箱上的说明。在电机接线之前要先用相序指示计确定三相电源的旋转方向并按照规定的旋转方向连接电机的接线。

6 使用

6.1 润滑油添加

本公司产品一般都未带润滑油出厂，在设备运行前请先按使用说明书加润滑油。



在标记有该符号的位置上，给齿轮箱加入润滑油。

6.2 设备检查

检查油面高度，润滑油冷却或者供油系统管路的密封性。

检查冷却装置，截止阀的开启状态。

配备了止回装置的齿轮箱，检查电机接线是否正确。

检查轴封是否有效。

检查旋转的零部件是否与其它零件接触。

6.3 启动

配置了电机油泵的齿轮箱应当保证在启动设备前首先开启油泵电机。

检查自由状态下转动方向是否正确（同时监听轴转动时是否有异常研磨噪声）。

运行检查时要保证轴上没有输出元件，同时开启相关的监测和保护设备。

无论什么时候，只要怀疑出现了不正常的运行现象（例如 温升、噪声、振动等异常），应立即关掉电机，并查明原因。

必要时与BONENG公司联系

7 检查与维护

7.1 定期检查与维护

用户要定期对齿轮箱进行维护和保养，要定期检查润滑油的使用状态，定期清理通气帽、风扇、冷却盘管和齿轮箱表面的灰尘和异物，保持齿轮箱清洁，保证齿轮箱的正常运行。

7.2 检查与维护的周期

检查油温	每日
检查齿轮箱的不正常的噪声	每日
检查油面高度	每月
检查齿轮箱的漏油	每月
检验油中的水分	在400工作小时后,至少每年一次
在起动之后的首次换油	在400工作小时后
其后的换油	每5000工作小时
清理滤油器	每3个月
清理通气帽	每3个月
清理风扇、风扇罩和齿轮箱箱体	和换油同时进行
检查冷却螺旋管的沉积物	大约每2年,和换油同时进行
检查润滑油空气冷却器	和换油同时进行
检查润滑油水冷却器	和换油同时进行
检查紧固螺栓的紧固程度	第一次换油后,其后每隔一次换油
对于齿轮箱的全面检查	大约每2年和换油同时进行
清理通气螺丝	每3个月



所列出的期限是取决于齿轮箱的工作条件的。

这些期限是在如下条件下的平均值：

每日的工作时间24小时

负载系数100%

输入装置的转速1800 RPM

最高温度90（仅仅限于矿物油）

100（仅仅限于合成油）

7.3 检查与维护的注意事项

切断电源，防止触电，等待齿轮箱冷却。

油位的检查：拧下油尺，检查油位。使用油镜的产品，油位必须在油镜的中间位置。

油的检查：移去油塞，取油样，检查油的粘度指数；如果油明显浑浊，建议尽快更换。

油的更换：

不同的润滑剂禁止相互混合使用。

冷却后油的粘度会增大,放油困难,换油时齿轮箱应保持温热。

在油塞下面放一个接油盘,拆下油塞/油尺/通气帽,将油全部排除后装上油塞。

注入同牌号的新油,油量应与安装方位一致(见铭牌);若牌号不同则向我司售后服务咨询。

在油尺或油镜处检查油位,装上油尺及通气帽。

8 故障处理

8.1 故障、原因和措施

维修工作一定要由经过培训后素质合格的人员谨慎地进行

故障	原因	措施
在齿轮箱的紧固件处有大的噪声	紧固件松动	将螺栓/螺母拧紧到规定的扭矩。 更换损坏了的螺栓/螺母。
齿轮箱的噪声变化	齿轮箱的齿轮发生损坏	和客户服务部联系 检查所有的齿轮， 更换损坏了的零件。
	轴承间隙过大	和客户服务部联系。 调整轴承的间隙。
	轴承损坏	和客户服务部联系。 更换损坏的轴承。
工作温度过高	箱体里面的油面过高	检查油面的高度，如果有必要的话，调整。
	油过于陈旧	和客户服务部联系 检查上一次换油的时间， 如果有必要的话就更换。
	油受到严重污染	和客户服务部联系 换油
	在配备了润滑油冷却系统的齿轮箱上： 冷却剂的流量过低或者过高	全面调节进口和出口管道的阀门。 检查水冷装置的自由流量。
	冷却剂温度过高	检查温度并按需调节。
	通过水冷装置的油流过低，其原因： 虑油器严重堵塞	清理滤油器
	油泵的机械故障	和客户服务部联系 检查油泵的功能是否正常 休息或者换新。
	在配备了风扇的齿轮箱上： 风扇盖的空气入口和/或箱体严重污染	清理风扇盖和箱体。
配备了冷却盘管的齿轮箱： 冷却盘管里面结垢	和客户服务部联系 清理或者更换冷却盘管。	

故障	原因	措施
轴承处的温度过高	齿轮箱箱体里面的油面过高或者过低	在室温下检查油面的高度并按需加油。
	油过于陈旧	和客户服务部联系 检查上次换油的时间。
	油泵的机械故障	和客户服务部联系 检查油泵的工作是否正常。 修理或者换新油泵
	轴承损坏	和客户服务部联系 查阅操作人员在振动测量中所获得的数据。 检查并按需更换轴承。
轴承处的振幅升高	轴承损坏	和客户服务部联系 检查并按需更换轴承。
	齿轮损坏	和客户服务部联系 检查并按需更换齿轮。
止回装置的温度过高 止回功能失效	止回装置损坏	和客户服务部联系 检查并按需更换止回装置。
齿轮箱漏油	箱体盖或者连接处的密封不良	检查密封和连接处，如果必要的话，更换新的。将连接处密封好。
	径向轴封环失效	和客户服务部联系 换新的径向密封。
油中有水	油中有杂物	用试管检查油的状态是否有水分存在。实验室分析油。
	润滑油冷却器或者冷却盘管失效	和客户服务部联系 找出并修理泄漏之处。 更换冷却器或者冷却盘管。
	齿轮箱受到机器间的通风过来的凉空气而产生凝霜	用合适的保温材料将齿轮箱保护起来。 关闭空气的出口或者在结构上改变其方向。
压力监测装置报警（配备了压力润滑、润滑油水冷却装置和空气冷却装置的齿轮箱）	油压<0.5巴	在室温下检查油面高度，按需加油。 检查滤油器，按需更换。 和客户服务部联系。 检查油泵的功能是否正常。 修理或者更换油泵。
双切换式滤器的指示器发出警报	双切换式滤器堵塞	按照说明将切换滤器进行切换， 将堵塞了的滤芯取下来并清理。
供油系统的故障		看使用说明书中关于供油系统的说明。

对于客户自己无法排除的故障请和我公司售后服务部联系。

售后服务

各种传动设备，客户发现有质量问题时，不要先拆卸零件，应说明以下情况然后与本公司售后服务部联系，说明现象后确认问题所在，再采用较理想的方法处理。

登录“www.boneng.com”

点击“服务”

点击“售后服务”



博能传动（沈阳）有限公司

控制器/驱动器：024-31271571

马达/齿轮马达/齿轮箱：024-31292571

博能传动（天津）有限公司

控制器/驱动器：022-86928559

马达/齿轮马达/齿轮箱：022-26929558

博能传动（开封）有限公司

控制器/驱动器：0371-23335230

马达/齿轮马达/齿轮箱：0371-23277771

博能传动（潍坊）有限公司

控制器/驱动器：0536-4699687

马达/齿轮马达/齿轮箱：0536-4699667

博能传动（长沙）有限公司

控制器/驱动器：0731-88386958

马达/齿轮马达/齿轮箱：0731-88380725

博能传动（苏州）有限公司

控制器/驱动器 苏南区：0512-66182005

马达/齿轮马达/齿轮箱 苏南区：0512-66189918

控制器/驱动器 浙沪区：0512-66182005

马达/齿轮马达/齿轮箱 浙沪区：0512-66189918

控制器/驱动器 苏皖区：0512-66182005

马达/齿轮马达/齿轮箱 苏皖区：025-52171612

博能传动（美国）有限公司

技术支持/调试/售后服务：

1250 E 222nd Euclid, OH 44117, United States

Email: America@boneng.com

Tel: 1-216-618-3099 / 1-216-618-0138

博能传动（印度）有限公司

技术支持/调试/售后服务：

Plot No. E-10/3, MIDC sinnar (Malegaon) Industrial Area,
Nashik, 422123, Maharashtra, India.

Email: india@boneng.com

Tel: +91-11-4507 6293 / +91-22-2781 3385

其他地区

控制器/驱动器：0512-66182005

马达/齿轮马达/齿轮箱：0512-66189918

Gearbox type

H204~H218 B204~B218
H305~H318 B304~B318
H407~H418 B405~B418

H...HS

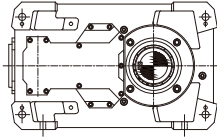

B...HS

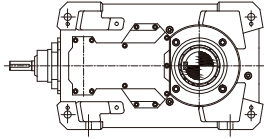

H...HH

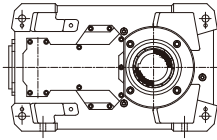

B...HH

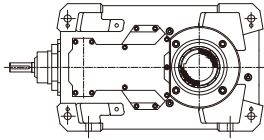

H...HD

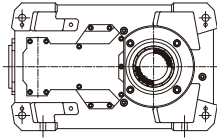

B...HD

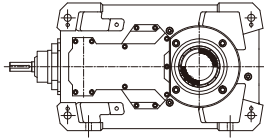

H...HK

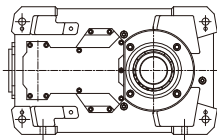

B...HK

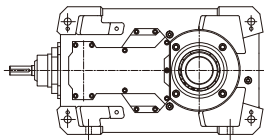

Gearbox type

H204~H218 B204~B218

H305~H318 B304~B318

H407~H418 B405~B418

H...VS

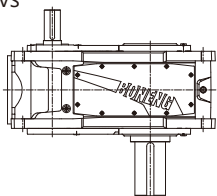

B...VS

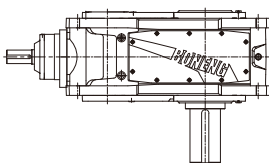

H...VH

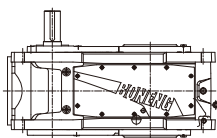

B...VH

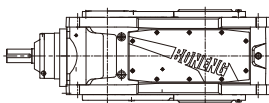

H...VD

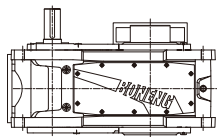

B...VD

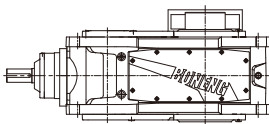

H...VK

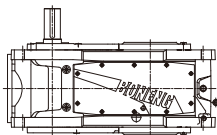

B...VK

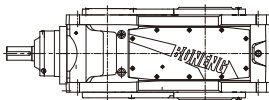

Gearbox type

H219~H226

H319~H326 B319~B326

H419~H426 B419~B426

H...HS

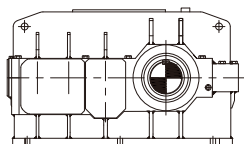

B...HS

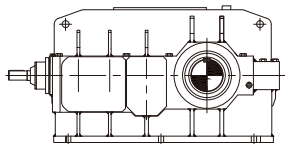

Contents

Important notes	31
1 Safety information	32
2 Technical information	33
2.1 The name plate information	33
2.2 Type description	34
2.3 Noise level of the gearbox	34
2.4 Temperature rising	38
2.5 Notes	39
3 Installation and dismantlement	40
3.1 Notes before installation	40
3.2 Preparations	40
3.3 Installation of gearbox	41
3.4 Assembly of coupling	44
3.5 Assembly of belt wheel or chain wheel	45
3.6 Assembly of hollow shaft of gearbox	46
3.7 Disassembly of hollow shaft of gearbox	47
3.8 Assembly of accessories	48
3.9 Final work	49
4 Installation of gearbox	49
4.1 H&B Installation position information H&B	49
4.2 H&B Installation direction diagram	49
4.3 General information	50
5 Lubrication/Cooling/Heating	52
5.1 Lubrication	52
5.2 Cooling	55
5.3 Heating	58
5.4 Backstop	59
6 Application	59
6.1 Fill the lubrication oil	59
6.2 Check the device	60
6.3 Start	60
7 Checks and maintenance	60
7.1 Check and maintenance regularly	60
7.2 Periods of checks and maintenance	60
7.3 Notes for checks and maintenance	61
8 Fault treatment	62
8.1 Fault、reason and measures	62
After-sales service	65

Important notes

During installation, please pay attention to the safety notes and warning in this book!



Suggestions and useful information



Harmful situations:

Possible result: damage transmission device and the environment



If you conform to the regulations in this manual, there won't be any fault, at the same time, it can satisfy the requirements of quality defect claim. So before the transmission device starts working, please read this instruction;

This instruction book contains important installation and maintenance notes, please keep this instruction book in a place near the device for reference.

1 Safety information

Safety information mainly involve the applications of gearmotor. When running gearmotor, please note the relevant notes.

This instruction is an integral part of the gearmotor supplied.

All persons involved in the installation, operation, maintenance and repair of the gearmotor must have read the instructions and comply with them.

Conforming to the instruction strictly is a necessity for realizing non-fault running and performing any quality assurance requirement.

Under the premise of conforming to instruction, please pay attention to:

- National (Local) regulations for relevant safety and accident preventions;
- Special regulations and requirements of relevant devices;
- Warning and safety mark on device.

The following situations will cause human injury and property loss:

- Incorrect running;
- Wrong installation or operation;
- Dismantle the protect cover or housing against the instructions.

Any damage or stop caused by disregarding this instruction book will not be responsible by the company.

To seek for technical advance, we reserve the rights to modify the instructions. With continuous improvements, we will further improve its performance and safety performances on the foundation of keeping the basic characteristics.

2 Technical information

2.1 The name plate information

⊕ BONENG ⊕	
Type	
n ₂	RPM
P ₁ kW	T ₂ N · m
n ₁ RPM	i
Oil	Wt. kg
NO.	Date
⊕ ⊕	

Product type(The "M" prefix indicates CMAC certification)

Output speed (only for directly connected motor)

Rated input power kW (it means motor power for directly connected motor)

Rated output torque N · m

Rated input speed RPM (it means motor speed for directly connected motor)

Nominal ratio

Lubrication oil viscosity

Weight

Product number

Production date

Data on nameplate are very important, please read them carefully and keep them clean.

When services are needed, please provide the product number,used time and fault details.

2.2 Type description

2.2.1 Product range:

H204~H226 B204~B218
 H305~H326 B304~B326
 H407~H426 B405~B426

Type designation :

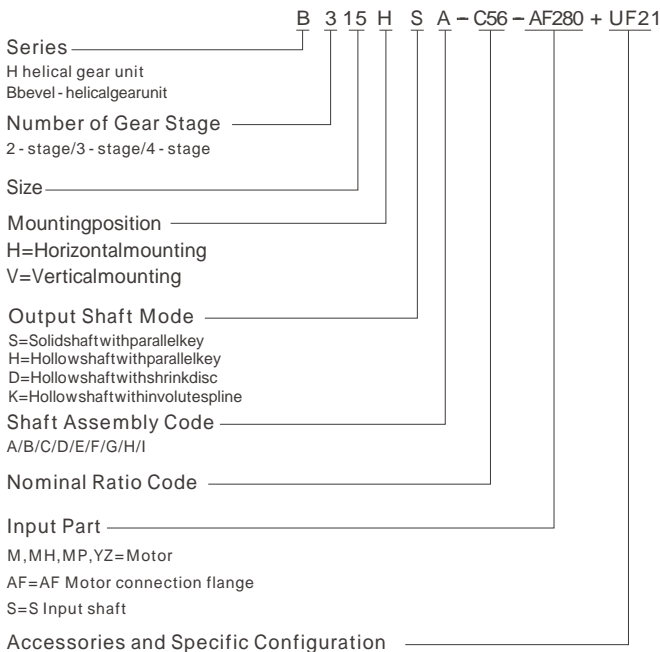

Accessories code recommended on the catalog.

The model number with "M" prefix indicates that the product has been CMAC certified, for example: MB307HSA - C45;

Type designation is only for reference, special type, please consult.

2.3 Noise level of gearbox

Noise level conforms to relevant national standard, industrial standard and enterprise standard.

Inspection of noise is done according to sound density theory, it is inspected in a distance of 1 meter (the surface noise region).

Noise level is tested when gearbox is under good working situation with regulated rated input speed n_1 and rated input power p_1 stated on the name plate. If several figures are given, the highest speed and power values apply.

If the repeated measurement can't get the final result, you should apply the inspection result obtained from the test platform of our company.

Measurement of surface noise level doesn't include the noise of accessories of lubrication device

2.3.1 Noise level of the helical gearbox without fan (H series):

Measuring - surface noise level LPA in dB(A) for helical gearbox without fan																											
Type	Ratio	Speed r/min	Size																								
			3	4	5	6	7	8	9	10	11	12	13	14	15	16	17	18	19	20	21	22	23	24	25	26	
H2	6.3	1500	-	71	74	75	76	77	79	79	80	81	81	82	84	85	85	86	-	-	-	-	-	-	-	-	
		1000	-	66	69	70	71	72	74	74	75	76	76	77	80	80	80	81	83	83	84	-	-	-	-	-	-
	10	750	-	63	66	67	67	69	70	71	72	73	73	74	76	77	77	78	80	80	81	81	81	-	-	-	-
		1500	-	69	72	73	74	75	77	77	78	79	79	80	82	83	83	84	-	-	-	-	-	-	-	-	-
	11.2	1000	-	64	67	68	69	70	72	72	73	74	74	75	77	78	78	79	81	81	82	82	83	83	-	-	-
		750	-	61	64	65	66	67	69	69	70	71	71	72	74	75	75	76	77	78	79	79	79	80	81	81	81
	16	1500	-	66	69	70	71	72	74	74	75	76	77	78	80	80	81	82	83	84	84	85	-	-	-	-	-
		1000	-	61	64	65	66	68	69	69	70	71	72	73	75	75	76	77	78	79	79	80	80	81	81	81	82
	22.4	750	-	1)	61	62	63	64	66	66	67	68	69	70	72	72	73	73	75	75	76	76	77	78	78	78	78
		1500	-	-	68	69	73	74	74	75	77	77	78	79	81	81	82	83	83	84	85	86	86	87	-	-	-
	H3	-	1000	-	-	63	65	68	69	69	71	72	73	73	74	76	77	77	78	79	79	81	81	81	82	83	83
			750	-	-	60	61	65	66	65	67	69	69	70	71	73	73	74	75	75	76	77	78	78	79	79	80
35.5		1500	-	-	65	67	70	71	71	73	74	75	76	76	78	79	79	80	81	81	83	83	84	84	-	-	-
		1000	-	-	1)	62	65	66	66	68	69	70	71	72	73	74	75	75	76	77	78	78	79	79	80	80	
63		750	-	-	1)	1)	62	63	63	65	66	67	67	68	70	71	71	72	73	73	75	75	76	76	77	77	
		1500	-	-	62	64	67	68	68	70	71	72	73	74	76	76	77	78	78	79	80	81	81	82	82	83	
71		1000	-	-	1)	1)	62	63	63	65	66	67	68	69	71	71	72	73	73	74	75	76	76	77	77	78	
		750	-	-	1)	1)	1)	1)	1)	62	63	64	65	66	68	68	69	70	70	71	72	72	73	73	74	75	
H4		100	1500	-	-	-	-	66	67	68	69	70	71	72	73	75	75	76	76	77	78	78	79	80	81	81	
			1000	-	-	-	-	62	63	63	64	65	66	67	68	70	70	71	72	72	73	73	74	74	76	76	77
		140	750	-	-	-	-	1)	1)	1)	61	62	63	64	64	66	67	68	68	69	69	70	70	71	72	73	73
			1500	-	-	-	-	64	65	66	66	68	68	69	70	72	73	73	74	74	75	75	76	76	78	78	79
	160	1000	-	-	-	-	1)	60	61	62	63	64	64	65	67	68	68	69	70	70	71	71	72	73	74	74	
		750	-	-	-	-	1)	1)	1)	60	61	61	62	64	64	65	66	66	67	67	68	68	70	70	71	71	
	250	1500	-	-	-	-	61	62	63	64	65	66	67	67	69	70	70	71	72	72	73	73	74	75	76	76	
		1000	-	-	-	-	1)	1)	1)	1)	60	61	62	63	64	65	66	66	67	68	68	69	70	71	72	72	
	280	1500	-	-	-	-	61	62	63	64	65	66	67	67	69	70	70	71	72	72	73	73	74	75	76	76	
		1000	-	-	-	-	1)	1)	1)	1)	60	61	62	63	64	65	66	66	67	68	68	69	70	71	72	72	
	450	1500	-	-	-	-	1)	1)	1)	1)	1)	1)	1)	1)	61	62	62	63	64	64	65	65	65	67	68	68	
		750	-	-	-	-	1)	1)	1)	1)	1)	1)	1)	1)	61	62	62	63	64	64	65	65	65	67	68	68	

1) LPA < 60dB(A)

2.3.2 Noise level of helical gearbox (H··) with fan:

Measuring - surface noise level LPA in dB(A) for helical gearbox without fan																												
Type	Ratio	Speed r/min	Size																									
			3	4	5	6	7	8	9	10	11	12	13	14	15	16	17	18	19	20	21	22	23	24	25	26		
H2	6.3	1500	-	75	76	77	80	81	82	84	85	86	88	90	92	94	96	96	-	-	-	-	-	-	-	-		
		-	1000	-	69	71	72	74	75	77	79	80	81	83	84	85	86	87	88	88	89	90	-	-	-	-	-	
		10	750	-	66	68	69	70	72	73	75	76	77	79	80	81	82	83	83	84	84	85	85	86	-	-	-	
	11.2	1500	-	73	75	77	79	80	81	82	85	88	90	91	92	93	95	95	-	-	-	-	-	-	-	-	-	
		-	1000	-	68	69	70	72	73	75	77	79	80	82	83	84	85	85	86	86	87	87	87	88	88	-	-	
		16	750	-	64	66	67	69	70	71	73	74	76	78	79	79	80	81	81	82	82	83	83	83	84	84	85	
	18	1500	-	71	73	75	77	78	80	82	84	86	87	90	91	92	93	94	94	95	95	95	-	-	-	-	-	
		-	1000	-	65	67	68	71	72	73	75	77	78	80	81	82	83	83	84	85	85	86	86	86	87	87	87	
		28	750	-	62	64	65	67	68	69	71	73	74	75	77	78	79	79	80	80	81	81	81	82	82	82	83	
	H3	22.4	1500	-	-	71	72	75	75	77	77	80	80	81	81	84	84	84	85	-	-	-	-	-	-	-	-	
			-	1000	-	-	65	66	69	70	71	72	74	75	75	75	78	78	78	79	-	-	-	-	-	-	-	-
			35.5	750	-	-	62	62	66	67	67	68	70	70	71	72	74	74	75	76	-	-	-	-	-	-	-	-
40		1500	-	-	70	71	73	74	76	76	79	79	80	80	83	82	83	83	-	-	-	-	-	-	-	-	-	
		-	1000	-	-	64	65	67	68	69	70	73	73	73	74	77	77	77	77	-	-	-	-	-	-	-	-	
		63	750	-	-	62	62	63	64	65	66	69	69	69	70	72	73	73	73	-	-	-	-	-	-	-	-	
71		1500	-	-	70	70	72	72	75	75	78	78	78	78	82	82	82	82	-	-	-	-	-	-	-	-	-	
		-	1000	-	-	64	64	65	66	68	69	71	72	72	72	75	75	75	76	-	-	-	-	-	-	-	-	
		112	750	-	-	61	61	62	62	64	65	67	67	68	68	71	71	71	72	-	-	-	-	-	-	-	-	

2.3.3 Noise level of the bevel-helical gearbox without fan (B...):

Measuring - surface noise level LPA in dB(A) for bevel - helical gearbox without fan																											
Type	Ratio	Speed r/min	Size																								
			3	4	5	6	7	8	9	10	11	12	13	14	15	16	17	18	19	20	21	22	23	24	25	26	
B2	5	1500	72	75	78	80	82	83	84	86	87	88	89	90	93	-	-	-	-	-	-	-	-	-	-	-	
		1000	66	70	72	73	76	77	78	79	81	82	83	84	86	88	89	-	-	-	-	-	-	-	-	-	
		750	1)	63	65	66	69	71	72	73	74	75	77	78	80	82	83	84	-	-	-	-	-	-	-	-	-
	9	1500	67	71	74	75	77	79	80	81	83	84	85	86	87	89	-	-	-	-	-	-	-	-	-	-	-
		1000	61	65	67	69	72	73	74	76	77	78	80	81	82	83	85	86	-	-	-	-	-	-	-	-	-
		750	1)	1)	60	63	65	66	67	69	71	72	73	74	76	77	78	79	-	-	-	-	-	-	-	-	-
	14	1500	63	66	69	71	72	74	75	77	78	80	81	82	85	85	-	-	-	-	-	-	-	-	-	-	-
		1000	1)	61	63	65	67	68	69	71	72	74	75	77	79	80	81	81	-	-	-	-	-	-	-	-	-
		750	1)	1)	1)	1)	60	62	63	64	66	67	68	70	72	73	74	75	-	-	-	-	-	-	-	-	-
	22.4	1500	63	66	69	71	72	74	75	77	78	80	81	82	85	85	-	-	-	-	-	-	-	-	-	-	-
		1000	1)	61	63	65	67	68	69	71	72	74	75	77	79	80	81	81	-	-	-	-	-	-	-	-	-
		750	1)	1)	1)	1)	60	62	63	64	66	67	68	70	72	73	74	75	-	-	-	-	-	-	-	-	-
B3	12.5	1500	65	68	71	74	75	76	77	79	81	83	84	85	86	87	87	88	89	90	91	92	-	-	-	-	
		1000	1)	63	66	68	69	70	72	73	75	77	78	80	80	81	82	82	84	85	86	86	88	88	89	90	-
		750	1)	1)	1)	61	62	64	65	66	68	71	71	73	73	74	75	75	77	78	79	79	81	82	83	84	
	31.5	1500	60	65	67	70	71	71	72	74	77	79	80	81	82	83	83	84	86	86	88	88	-	-	-	-	
		1000	1)	1)	62	65	65	66	66	69	71	73	75	76	76	77	77	78	80	81	82	83	84	85	86	87	
		750	1)	1)	1)	1)	1)	1)	1)	62	65	67	68	69	70	71	72	74	74	75	76	78	80	80	80	80	
	56	1500	1)	61	64	70	67	68	68	70	73	75	76	78	78	79	79	80	82	83	84	84	-	-	-	-	
		1000	1)	1)	1)	63	62	62	62	65	68	70	71	72	73	73	74	75	76	77	78	79	81	81	83	83	
		750	1)	1)	1)	1)	1)	1)	1)	1)	61	63	64	65	66	67	67	68	70	70	72	72	74	75	76	76	
	63	1500	1)	61	64	70	67	68	68	70	73	75	76	78	78	79	79	80	82	83	84	84	-	-	-	-	
		1000	1)	1)	1)	63	62	62	62	65	68	70	71	72	73	73	74	75	76	77	78	79	81	81	83	83	
		750	1)	1)	1)	1)	1)	1)	1)	1)	61	63	64	65	66	67	67	68	70	70	72	72	74	75	76	76	
90	1500	-	-	64	65	67	68	70	72	75	76	77	79	80	81	82	83	84	85	86	86	87	88	87	89		
	1000	-	-	1)	1)	61	63	64	67	69	70	72	73	74	75	76	77	78	79	80	80	81	82	82	83		
	750	-	-	1)	1)	1)	1)	1)	1)	62	64	65	66	68	68	69	71	71	72	73	74	74	75	75	76		
B4	80	1500	-	-	60	61	63	65	66	68	71	72	73	75	76	77	78	79	80	81	82	82	83	84	85	86	
		1000	-	-	1)	1)	61	63	64	67	69	70	72	73	74	75	76	77	78	79	80	80	81	82	82	83	
		750	-	-	1)	1)	1)	1)	1)	1)	62	64	65	66	68	68	69	71	71	72	73	74	74	75	75	76	
	125	1500	-	-	60	61	63	65	66	68	71	72	73	75	76	77	78	79	80	81	82	82	83	84	85	86	
		1000	-	-	1)	1)	1)	1)	61	63	65	67	68	69	71	71	72	74	75	76	77	78	78	79	80		
		750	-	-	1)	1)	1)	1)	1)	1)	61	62	64	65	66	67	68	69	69	70	71	72	73	73	73	73	
	140	1500	-	-	1)	1)	1)	62	63	65	67	69	70	71	73	73	75	76	77	78	79	80	80	81	82		
		1000	-	-	1)	1)	1)	1)	1)	62	63	64	66	67	68	69	70	71	72	73	73	74	75	76	77		
		750	-	-	1)	1)	1)	1)	1)	1)	62	63	64	66	67	68	69	70	71	72	73	73	74	75	76	77	
	224	1500	-	-	1)	1)	1)	62	63	65	67	69	70	71	73	73	75	76	77	78	79	80	80	81	82		
		1000	-	-	1)	1)	1)	1)	1)	62	63	64	66	67	68	69	70	71	72	73	73	74	75	76	77		
		750	-	-	1)	1)	1)	1)	1)	1)	61	62	63	64	66	67	68	69	70	71	72	73	73	74	75	76	
250	1500	-	-	1)	1)	1)	62	63	65	67	69	70	71	73	73	75	76	77	78	79	80	80	81	82			
	1000	-	-	1)	1)	1)	1)	1)	62	63	64	66	67	68	69	70	71	72	73	73	74	75	76	77			
	750	-	-	1)	1)	1)	1)	1)	1)	61	62	63	64	66	67	68	69	70	71	72	73	73	74	75	76		
400	1500	-	-	1)	1)	1)	62	63	65	67	69	70	71	73	73	75	76	77	78	79	80	80	81	82			
	1000	-	-	1)	1)	1)	1)	1)	62	63	64	66	67	68	69	70	71	72	73	73	74	75	76	77			
	750	-	-	1)	1)	1)	1)	1)	1)	61	62	63	64	66	67	68	69	70	71	72	73	73	74	75	76		

1) LPA < 60dB(A)



2.3.4 Noise level of bevel-helical gearbox (B··) with fan:

Measuring - surface noise level LPA in dB(A) for bevel - helical gearbox without fan																										
Type	Ratio	Speed r/min	Size																							
			3	4	5	6	7	8	9	10	11	12	13	14	15	16	17	18	19	20	20	22	23	24	25	26
B2	5	1500	73	76	79	81	83	84	85	87	88	89	91	92	94	-	-	-	-	-	-	-	-	-	-	-
		1000	67	71	73	74	77	78	79	80	82	82	84	85	87	89	90	-	-	-	-	-	-	-	-	-
		750	61	64	66	67	70	71	72	73	75	76	77	78	81	82	83	85	-	-	-	-	-	-	-	-
	8	1500	70	73	75	76	78	81	82	83	84	85	86	87	88	90	-	-	-	-	-	-	-	-	-	-
		1000	63	67	68	70	73	74	75	77	79	80	81	82	83	84	86	87	-	-	-	-	-	-	-	-
		750	1)	61	62	64	66	67	68	70	72	73	74	75	77	78	79	80	-	-	-	-	-	-	-	-
	9	1500	67	71	74	76	78	79	80	81	83	84	87	88	89	90	-	-	-	-	-	-	-	-	-	-
		1000	60	64	67	68	70	72	73	74	78	79	80	81	82	83	84	84	-	-	-	-	-	-	-	-
		750	1)	1)	61	63	65	67	68	69	71	72	73	73	74	74	75	76	-	-	-	-	-	-	-	-
	22.4	1500	67	71	74	76	78	79	80	81	83	84	87	88	89	90	-	-	-	-	-	-	-	-	-	-
		1000	60	64	67	68	70	72	73	74	78	79	80	81	82	83	84	84	-	-	-	-	-	-	-	-
		750	1)	1)	61	63	65	67	68	69	71	72	73	73	74	74	75	76	-	-	-	-	-	-	-	-
B3	12.5	1500	69	72	75	77	79	80	81	82	83	85	88	89	90	91	93	93	93	93	95	95	-	-	-	-
		1000	62	65	68	69	71	72	73	74	77	78	80	82	83	83	84	85	86	86	88	88	89	90	91	-
		750	1)	1)	63	64	66	68	69	70	71	73	74	75	76	77	78	78	79	79	81	81	82	84	85	85
	31.5	1500	67	69	72	73	74	75	77	79	82	84	86	87	88	89	90	91	92	92	93	93	-	-	-	-
		1000	1)	63	65	66	67	69	71	72	73	75	77	78	79	80	81	82	83	83	85	86	86	87	88	89
		750	1)	1)	1)	1)	62	64	65	67	69	70	71	72	73	74	75	76	77	77	79	79	80	81	82	82
	56	1500	66	68	70	71	73	74	75	78	81	83	85	86	87	88	89	90	91	91	92	92	-	-	-	-
		1000	1)	61	63	64	66	68	69	71	73	75	77	78	79	80	71	81	82	82	83	84	84	85	86	86
		750	1)	1)	1)	1)	61	63	64	66	67	68	70	71	72	73	74	74	75	75	77	77	78	79	79	80
	90	1500	66	68	70	71	73	74	75	78	81	83	85	86	87	88	89	90	91	91	92	92	-	-	-	-
		1000	1)	61	63	64	66	68	69	71	73	75	77	78	79	80	71	81	82	82	83	84	84	85	86	86
		750	1)	1)	1)	1)	61	63	64	66	67	68	70	71	72	73	74	74	75	75	77	77	78	79	79	80

1) LPA < 60dB(A)

2.4 Temperature rising

When the ambient temperature is 40 °C, the running gearbox oil temperature is not exceeded 85 °C.

The allowable working temperature range of lubricating oil for gearbox is roughly as follows:

Mineral oil is about -10 ~ +90 °C (Up to +100 °C at moment);

Synthetic oil is about -20 ~ +100 °C (Up to +110 °C at moment);

2.5 Notes

(Following notes is related to the use of gearbox):

- ◆ When installed outdoor, direct sunlight should be avoided, otherwise concentrated heat will affect the gearbox performance.
- ◆ The gearbox performance. must not be cleaned using high-pressure cleaning equipment.
- ◆ All work such as inspection, maintenance and installation on gearbox should be done when gearbox is not in operation.
- ◆ No welding work should be done on gearbox, the gear - box must not be used as an earthing point for welding work. Welding will cause irreparable damage to fine gear wheel and bearings.
- ◆ If any changes are found during operation (for example, over heating or abnormal noise, etc), you should switch off driving device immediately.
- ◆ All the rotating components should be equipped with protective cover to prevent accidental contact of staffs, such as couplings, hydraulic coupler, gear wheel, driving belt wheel, etc.
- ◆ You should conform to the instructions on gearbox, for example, nameplate, arrow of the direction, etc. These nameplates and marks must be kept free from dirt and paint out all times.
- ◆ During assembly or disassembly work, the damaged bolts should be changed with new bolts with the same strength and category.
- ◆ The bad results caused by unreasonable application of couplings, self - modification to gearbox and application of the components of other companies are not included in “ three - guarantee ” services.
- ◆ Depending on operation conditions of gearbox, the surface, lubrication oil and components of gearbox may reach high temperature, avoid being burnt.
- ◆ When changing lubrication oil, take care to prevent scalding by hot oil.
- ◆ Gearbox should be laid on dry wooden foundation with no vibration and be covered well. When storing the gearbox and any independent components, you should take anti-rust measures, avoid rusting, the gearbox should not be piled together when stored.
- ◆ Unless there are other regulations in ordering contract, gearbox should not be stored or work in sites with strong acid, alkali, low temperature, high temperature and heavy polluted air, damp and the places with chemical articles.
- ◆ When shifting the gearbox, take care to avoid the shaft ends knocked, otherwise the gearbox may be damaged. When lifting, don't use the front threads at the shaft ends to attach eyebolts for transport.
- ◆ Spare parts must be purchased from BONENG.

3 Installation and dismantlement

3.1 Notes before installation



Confirm the gearbox in good condition(no damage during transporting or storing);
Confirm site environment conforms to nameplate content;
Standard ambient temperature of gearbox:
-20 ~+40 ; no oil, acid, harmful gas,
steam, radioactive substances. etc;
If the storage time of the gear box is more than one year, the service life of the lubricant in the bearing will be shortened.



Installing outdoor should avoid direct sunshine. In case of concentrated heat to influence smooth running of gearbox;
Special gearbox: allocated according to ambient condition;
During planning period, you should reserve enough space to maintain or repair;
If the gearbox is fitted with a fan, there should be sufficient space for air intake.

3.2 Preparations

Completely clean the preservative and pollutants, etc on the surface of input/output shaft and flange; be sure not to damage the oil sealing by solvents immersion;

Preparation of tools/materials: one group of spanner, torque spanner, assembly clamp tools, input and output fastening device, lubricant (anti-rust oil), medium of sealing bolts (thread locking adhesives).

3.3 Installation of gearbox

Foundation

Prepare rigid foundation or stable platform to install transmission device, at the same time, you should consider that the position of all parts will not change even if maximum torque is loaded on box.

The foundation of gearbox should be horizontal and leveled. It must be designed in such a way that no resonance vibrations are set up and no vibration are transmitted from adjacent foundations steel structures on which the box is to be mounted must be rigid. It must be designed according to the mass and torque taking into account the forces acting on the gearbox.

Fastening bolts or nuts must be tightened to the prescribed torque. For the correct torque, we recommend customer to use the bolts of the minimum strength class 8.8.

Lifting position

For the gearbox not installed with accessories, you should apply the four holes on gearbox to lift.

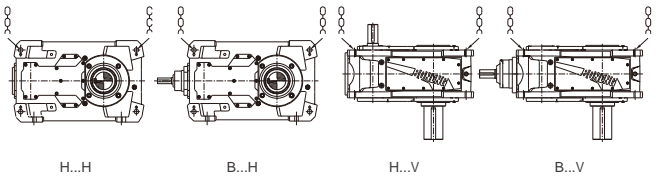

For gearbox installed with other accessories (such as motor and foundation), an additional attachment point may be required:

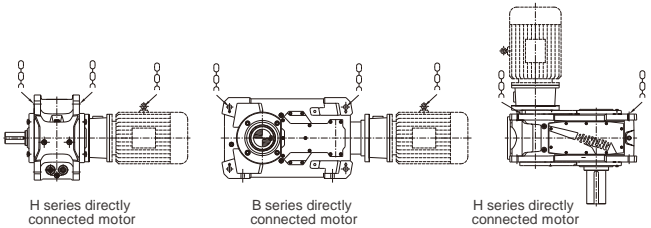

Note: Forbid to use the shaft end screw as the hoisting point after it is installed with hoisting ring.

Installation procedures of gearbox:

The initial alignment of the gearbox (the position marked in diagram) in a horizontal direction is done by the surfaces of the inspection of assembly cover:

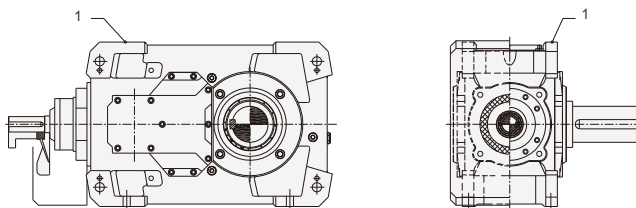

1 Initial alignment surface

The final fine alignment with the assemblies on the in - and - output side must be carried out accurately, by the shaft axes using:

· Ruler · spirit level · dial indicator · feeler gauge, etc ;

Only then should the gearbox be fastened and re - check the alignment situation.

Instruction: the precision degree of alignment is a very important factor to determine lifespan of shaft, bearing, couplings. Ensure the alignment tolerance to be zero.

According to different installation forms, you should pay attention to:

For foundation installation, central height should be correct aligned, when connecting couplings, you should calibrate the coaxiality of the two shafts; for flexible couplings, the flotation value should not exceed the permissible range of couplings, for rigid connection, you should ensure form tolerance of each installation and connection; you should ensure shaft with enough rigidity for long shaft connection.

When installing flange, protruding (or concave) steps should inosculate with housing. For flange installation and ollow shaft connection, ensure the contour and position tolerance for connection.

When installing torque arm, hollow shaft should be exactly aligned with the machine shaft, machine shaft swiveling and the gearbox vibration shouldn't exceed the flexible range, the arm should be fixed and tightened. Torque arm should be installed in the gearbox side, ensure no force. As showed in diagram:

When solid shaft is installed with coupling, belt pulleys gear, chain wheels and sprocket, etc, please don ' t make heavy clicking. The outer screw hole of output shaft should be pressed into connecting piece. Belt pulleys, gear wheels, and pug mill should consider about the radial force.

Torque arm installed on gearbox

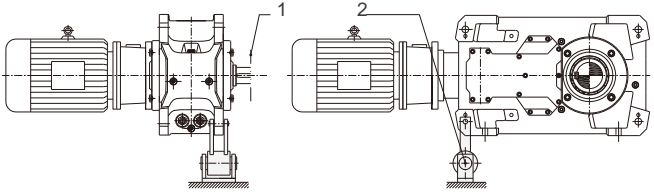

1 Driven machine side

2 Flexible support

Torque arm installed on foundation of gearbox

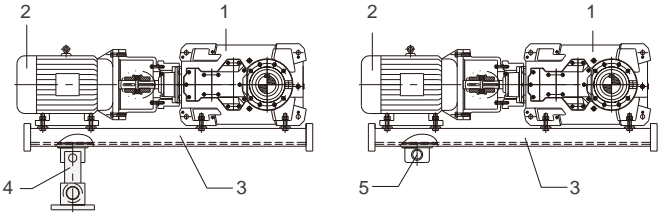

1 Gearbox

2 Motor

3 Foundation

4 Torque arm

5 Arm support

3.4 Assembly of coupling

The input drive end of gearbox should apply flexible coupling or hydraulic coupling.

When output shaft of gearbox is solid shaft, you should apply flexible coupling.

If rigid coupling or other input and output elements which generate additional radial force or axial force (for example, gear wheel, belt wheel, fly wheel, hydraulic coupling, etc) are to be used, this should be marked in contract.

When input shaft is connected with driving shaft, ensure input shaft has the same axial center with driving shaft. Coaxiality deviation will increase mechanical vibration, cause damage to bearing and influence gear wheel contact. As shown in the following diagram, after input shaft is connected with driving shaft through coupling, you should adjust it with meter, after relevant inspection parameter satisfies the requirements in the following table “ Coaxiality accuracy table ” , the equipment can be used. If threaded pins are included in coupling pair, they should be coated with anaerobic thread locking sealant (such as LOCTITE 243 or TONSAN 1243) before screwing in.

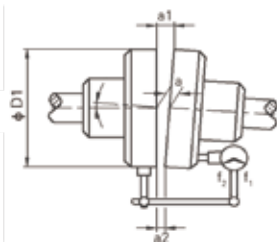

Angle deviation inspection

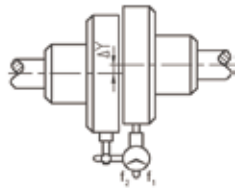

Deviation inspection

Coaxiality accuracy table:

Outer diameter	n<500r/min		500 ~ 1500r/min		>1500r/min	
	a1 - a2	Y	a1 - a2	Y	a1 - a2	Y
D 100	0.05	0.05	0.04	0.04	0.03	0.03
100<D 200	0.06	0.06	0.05	0.05	0.04	0.04
200<D 400	0.12	0.10	0.10	0.08	0.08	0.06
400<D 800	0.20	0.16	0.16	0.12	0.12	0.10



Instruction:

When circular velocity of coupling outer diameter is 30m/s or below, it should be statically balanced. When circular velocity of outer diameter exceeds 30m/s, it must be dynamically balanced.

3.5 Assembly of belt wheel or chain wheel

When input shaft and output shaft of gearbox are installed with belt wheel or chain wheel, make sure the force transmission part of belt wheel or chain wheel be close to shaft shoulder as possible. As shown in the following diagram:

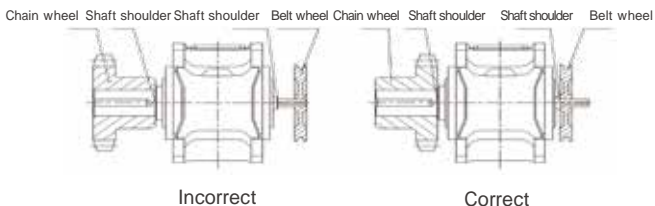

When installing belt wheel or chain wheel, ensure input shaft is centered to driving device, ensure maximum axial deviation tolerance value of the four centering points in diagram be 1mm every 1000mm.

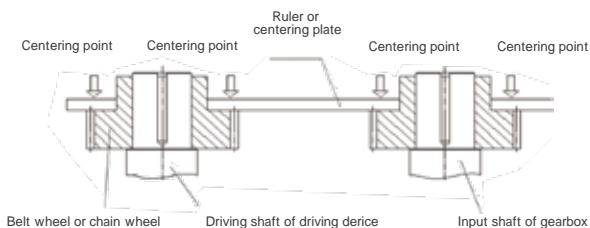

When installing belt wheel or chain wheel, ensure belt wheel and chain with certain tonus.



Incorrect



Correct

3.6 Assembly of hollow shaft of gearbox

When hollow shaft is connected with solid shaft clean and put anti-rust oil (hollow shaft must be exactly aligned with the machine shaft). Instead of the nuts and bolts shown in diagram, other types of equipment such as a hydraulic lifting equipment can be used.

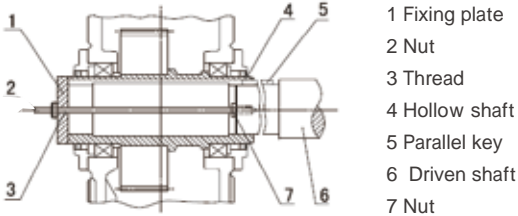

- 1 Fixing plate
- 2 Nut
- 3 Thread
- 4 Hollow shaft
- 5 Parallel key
- 6 Driven shaft
- 7 Nut

When hollow shaft of gearbox is equipped with locking plate, you should first cover locking plate on hollow shaft, then finish the installation of driving shaft of driven device, you should not screw the fastening bolts on locking plate before installing the driving shaft of driven device.



The locking plate being supplied can be directly installed, you can't tear it down before the first stress.

Before installing locking plate, ensure the bore of hollow shaft and the machine shaft must be absolutely free of grease in the area of the shrink disk seat.

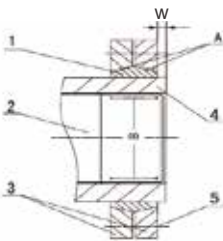

- 1 Inner ring
- 2 Driving shaft of driven device
- 3 Outer ring
- 4 Hollow shaft
- 5 Fastening bolt
- A Greased
- B Absolutely grease free
- W Installation width

When screwing the bolts on locking plate, it is forbidden to screw it according to adjacent order, you should screw fastening bolts along with equilateral triangle order according to installation requirements of locking plate. During each circulated screwing process, each bolt can only screw 1/4 circle.

Generally fixing bolts adopt 8.8 level, In case of high temperature or vibration impact, please take anti-loosing measures on screw joints. The screw torque of each fastening bolt as follows:

Bolt dimension (mm)	Tighten torque (N · m)	Bolt size (mm)	Tighten torque (N · m)
M6	15	M30	2000
M8	36	M36	3560
M10	72	M42	5720
M12	123	M48	8640
M16	295	M56	13850
M20	580	M64	14300
M24	1000	M72	20800

3.7 Disassembly of hollow shaft of gearbox

Disassembly of hollow shaft

Depending on the facilities available on site, the gear-box can be forced off the machine shaft using forcing screws in and end plate, a central threaded spindle or preferably a hydraulic lifting box. Each end face of hollow shaft are equipped with 2 screw holes to screw in bolts used to fixing end plate.

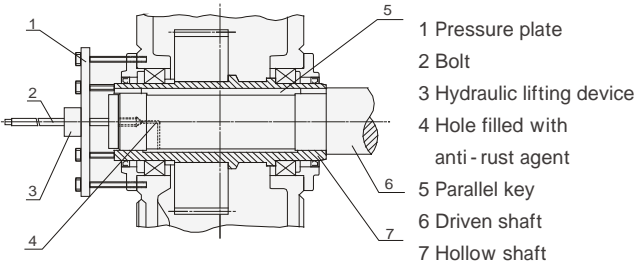

Note:

The pressure plate and auxiliary plate are not in the range of delivery. (Arrangement and dimension of screw hole of hollow shaft end can refer to technical diagram of BONENG)

When disassembling the hollow shaft of gearbox equipped with locking plate, the loosening of locking plate is reversed to fastening direction. Finish disassembly of driving shaft of driven device according to the above method after tearing down locking plate.

When disassembling locking plate, you should pay attention :



It is forbidden to loose bolts according to the adjacent order.

When outer ring of locking plate can't separate from inner ring, you can screw a few bolts into disassembly screw, separate inner ring from outer ring.

3.8 Assembly of accessories

The technical data of the involved accessories can refer to equipment list of specific order.

Electrical and controlling device should be wired according to instruction of device supplier.

For operation and maintenance, The operating instructions provided specifically for the order 's instruction.

Gearbox equipped with cooling coil

Before connecting cooling coil of cooling water, first take the blocking head off from the joint of cooling coil, completely washed spiral pipe to clean the dirty things.

Install inflow and outflow pipe of cooling water, the pressure should not be larger than 0.8MPa.

Gearbox equipped with water cooling lubrication oil

Before connecting cooling coil of cooling water, the end cap on water pipe should be taken down and washed clean.

Install inflow and outflow pipeline of cooling water. For water flow direction and joint position, please consult.

Electrically connect pressure inspection device.

Gearbox equipped with heating device

connect temperature monitor.

Electrically connect heating element.

Gearbox equipped with oil temperature measuring device

Electrically connect resistive thermometer with evaluating instrument (be prepared by customers).

Gearbox equipped with oil-level monitoring

Electrically connect oil - level monitor.

Gearbox equipped with speed transmitter

Electrically connect speed transmitter.

3.9 Final work

After installing gearbox, check all screw connections for tight fit.

After screwing down fasteners, you should check whether the alignment changes.

Inspect whether the removed devices are installed according to device list and the attached drawing.





4 Installation information

4.1 H&B installation position information

The mounting position details and type selection of gearbox, please refer BONENG selection manual (H&B series).

4.2 H&B Installation direction diagram

Symbols used in installation direction pages of gear - box and their meanings

Symbol		Meaning	
		Breather	Oil inlet
		Oil ruler	Oil glass
		Oil drain plug	

4.3 General information

The housing is equipped with adequately dimensioned lifting eyes, inspection and assembly cover with appropriate dimensions. The lubrication oil height in gearbox can be inspected with inspection oil ruler or observation oil lens. The housing is equipped with oil drain ruler, oil plug, oil lens and a vent cap.

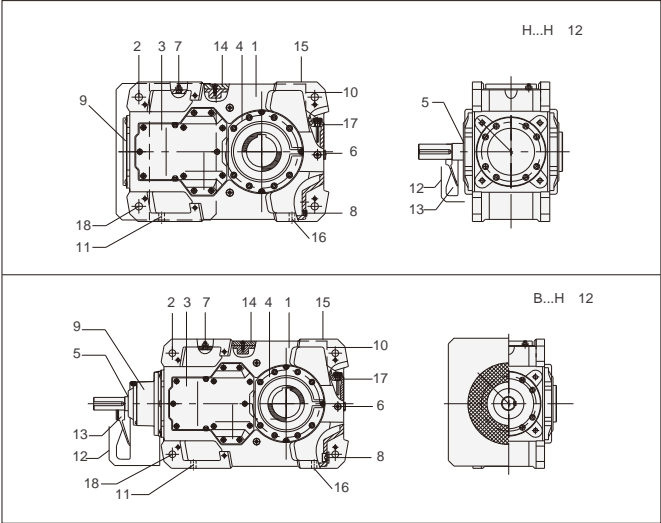

- | | |
|-------------------------------|---------------------------------|
| 1 Housing | 10 Nameplate |
| 2 Lifting eyes | 11 Fastener of gearbox |
| 3 Cover | 12 Fan cover |
| 4 Cover | 13 Fan |
| 5 Oil seal | 14 Inspection or assembly cover |
| 6 Oil indicator | 15 Alignment surface |
| 7 Vent cap | 16 Alignment thread |
| 8 Oil plug | 17 Oil filler/oil ruler |
| 9 Cover or bearing foundation | 18 Fastener of torque arm |

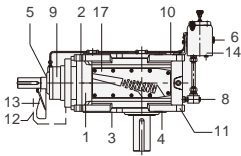

B...V 12(Compensation oil tank cap)

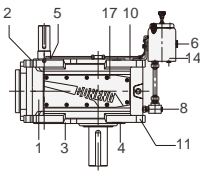
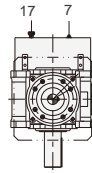

H...V 12(Compensation oil tank cap)

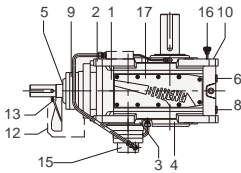
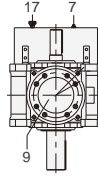

B...V 12(Shaft end oil pump)

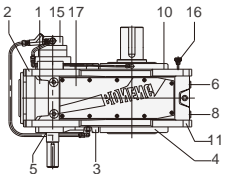
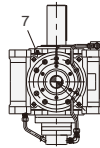

H...V 12(Shaft end oil pump)

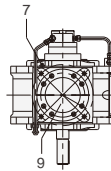

- | | | |
|-----------------|-------------------------------|---------------------------------|
| 1 Housing | 7 Vent cap | 13 Fan |
| 2 Lifting eyes | 8 Oil plug | 14 Additional oil box |
| 3 Cover | 9 Cover or bearing foundation | 15 Shaft end oil pump |
| 4 Cover | 10 Nameplate | 16 Oil filler/oil ruler |
| 5 Oil seal | 11 Fastener of gearbox | 17 Inspection or assembly cover |
| 6 Oil indicator | 12 Fan cover | |

5 Lubrication/Cooling/Heating

5.1 Lubrication

Lubrication selection:

Under the premise of the same viscosity level and category, you can choose internationally famous brand.

If you need to change the recommended viscosity level, please consult.

The following table lists the lubrication oil brand and ambient temperature corresponding to product specification.

Ambient temperature	-20 ~ +40
Viscosity brand number	VG320



When ambient temperature is lower than -10°C , you have to use synthetic oil.

To ensure lifespan of the products, we recommend synthetic oil.

When ambient temperature exceeds the above range, please consult technical department of BONENG.

Quantity of lubrication oil fill:

This quantity is a recommended value. According to the difference of gearbox level and ratio, the oil filling quantity is different. Please pay attention to oil ruler or oil glass scale as the indication of oil filling.

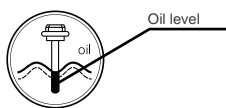

Oil ruler



Oil glass

For the products without oil ruler, oil filling quantity should according to product catalogue.

For products of the same type, under different installation directions, the oil filling quantity is different.

The following table lists suggested oil filling quantity for different installation directions of various series.

Oil quantity table (L)																		
Size	H2..H	H3..H	H4..H	B2..H	B3..H	B4..H	H2..V		H3..V		H3..V		B2..V		B3..V		B3..V	
3	—	—	—	—	—	—	—	—	—	—	—	—	—	—	—	—	—	—
4	10	—	—	10	9	—	25	—	—	—	—	—	28	—	28	—	—	—
5	15	15	—	16	14	16	23	10	35	13	—	—	41	20	32	12	36	15
6	16	17	—	19	15	18	27	11	37	15	—	—	50	23	35	13	40	16
7	27	28	25	31	25	30	58	22	60	25	50	20	75	35	52	22	60	30
8	30	30	27	34	28	33	62	25	72	30	60	25	90	38	67	28	70	35
9	42	45	48	48	40	48	100	42	100	40	95	38	115	53	115	48	110	60
10	45	46	50	50	42	50	110	46	110	45	110	45	135	60	125	52	130	67
11	71	85	80	80	66	80	160	60	170	66	165	65	190	86	180	75	180	75
12	76	90	87	95	72	90	180	70	190	75	180	75	215	95	200	85	195	85
13	135	160	130	140	130	145	—	80	—	115	—	95	—	100	—	95	—	130
14	140	165	140	155	140	150	—	90	—	126	—	105	—	110	—	110	—	150
15	210	235	230	220	210	230	—	140	—	180	—	150	—	145	—	165	—	200
16	215	245	235	230	220	235	—	150	—	190	—	160	—	160	—	190	—	235
17	290	305	290	320	290	295	—	175	—	190	—	190	—	210	—	210	—	215
18	300	315	305	335	300	305	—	185	—	200	—	200	—	220	—	240	—	250
19	320	420	360	—	380	480	—	—	—	—	—	—	—	—	—	—	—	—
20	340	450	380	—	440	550	—	—	—	—	—	—	—	—	—	—	—	—
21	370	500	440	—	460	600	—	—	—	—	—	—	—	—	—	—	—	—
22	400	560	480	—	490	650	—	—	—	—	—	—	—	—	—	—	—	—
23	430	620	520	—	530	710	—	—	—	—	—	—	—	—	—	—	—	—
24	450	650	550	—	600	810	—	—	—	—	—	—	—	—	—	—	—	—
25	760	735	880	—	640	1000	—	—	—	—	—	—	—	—	—	—	—	—
26	680	935	780	—	880	1150	—	—	—	—	—	—	—	—	—	—	—	—

Oil pond splash lubrication
Pressure lubrication

Forced lubrication
The data above are mean values

Lubrication method

Oil immersion lubrication:

When installing gearbox vertically, all the gear teeth and bearings are immersed in lubrication oil. When temperature rises and lubrication grease expands, the space needed is provided by the additional oil box jointed with gearbox by bolts.

Splash lubrication:

When installing gearbox horizontally, all the gear teeth and bearings are adequately splash-lubricated with oil brought by gears.

For non horizontal installation, when the speed of bearing and circumferential velocity of gear rise, splash lubrication system may be replaced or supported by a pressure lubrication system.

Lubrication system realized by additional devices:

When the speed of bearing or teeth peripheral is too high, splash lubrication has to be changed into forced lubrication system. Forced lubrication system includes shaft end pump or motor oil pump, filter, pipework. The direction of oil inlet and outlet flow from shaft end pumps is independent of the direction of gearbox rotation.

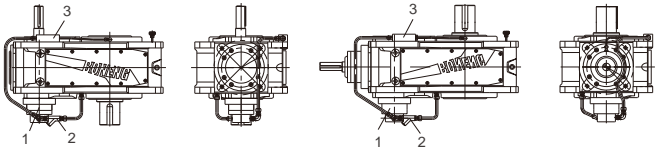

H...V 12(Shaft end pump)

B...V 12(Shaft end pump)

1 Shaft end pump

2 Filter

3 Oil distributing device

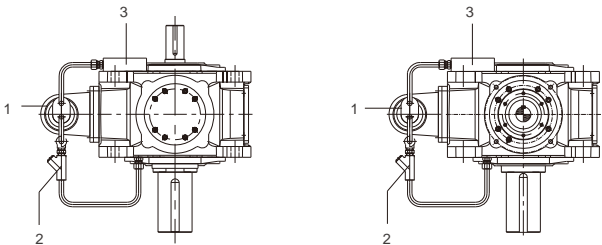

1 Motor pump

2 Filter

3 Oil distributing device



Note: Before starting the gearbox equipped with motor pump, the pump must be operated.

5.2 Cooling

Fan

Fan is mounted on a high - speed shaft of gearbox, it is protected by a cover and accidental contact. This fan absorbs air from the grilling on protective cover, then blow it to the air path on the side of gearbox. It hereby dissipates a certain amount of heat from the housing.

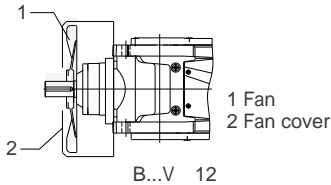

Instruction:

For the gearbox installed with fan, you should leave enough space to let air in when installing couplings or other components.

The correct dimension for the space being left is shown in the dimension diagram of gearbox documents.

Keep the fan clean. If the fan or the housing are dirty, cooling efficiency will be reduced.

Cooling coil

The position of cooling coil is inside the oil box of gearbox. In cooling spiral pipe is cooling water. Cooling water is provided by users. Either fresh water, seawater or brackish water can be used for cooling. When cooling water flows through cooling spiral pipe, the heat will be transmitted to cooling water from cooling spiral pipe, thus removing heat from the system.

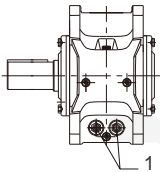

1 Water ports

B../H.. 12

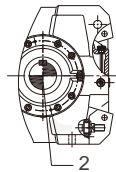

2 Output shaft

Flow of the cooling water (l/min)

Type	Size																	
	3	4	5	6	7	8	9	10	11	12	13	14	15	16	17	18	19	20-26
H2.H/B3.H	-	4	4	4	4	4	4	8	8	8	8	8	8	8	8	8	On request	On request
H3.H	-	-	4	4	4	4	4	4	8	8	8	8	8	8	8	8		
B2.H	-	4	8	4	8	4	8	8	8	8	8	8	8	8	8	8		
B4.H/H4.H	-	-	4	4	4	4	4	4	8	8	8	8	8	8	8	8		

Type	Size																	
	4	5	6	7	8	9	10	11	12	13	14	15	16	17	18	19-26		
H2.V/B3.V	4	4	4	4	4	8	8	8	8	8	8	8	8	8	8	On request		
H3.V	-	4	4	4	4	4	4	8	8	8	8	8	8	8	8			
B2.V	4	8	4	8	4	8	8	8	8	8	8	8	8	8	8			
B4.V/H4.V	-	4	4	4	4	4	4	8	8	8	8	8	8	8	8			



Note:

Cooling water can flow through gearbox from any direction. The pressure of cooling water should not exceed 0.8MPa. If the gearbox is being with drawn from service for a long time or the water may freezed, the cooling water should be drained off. Blow moisture with compressed air. The end of cooling spiral pipe must not be twisted, otherwise the spiral pipe will be damaged. Locking screw can't be tightened or demounted because the cooling spiral pipe will be damaged.

Cooling of cooling device

Gearbox with cooling device is designed to cool the lubrication oil, thus completing heat dissipation. Common cooling device: air cooling device and water cooling device, as shown in the diagram:

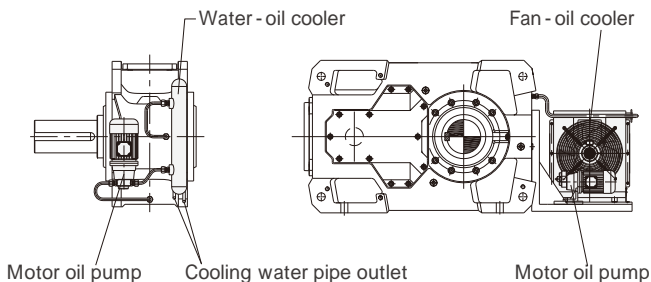

Air cooling device utilizes the surrounding air to cool, according to the difference of volume flow, lubrication oil flows through cooling device from one path or several paths, air blows through these paths from fan, getting cooling effect.



Instruction:

For the gearbox equipped with air cooling device, please ensure the air circulation from being impeded. The minimum distance from adjacent components and walls can be seen in diagrams in gearbox documents.

The principle of water cooling device is the same with air cooling device, the medium of cooling is changed from air into water. To ensure the best cooling effect, you should conform to the flow direction of cooling device. The inlet and outlet of cooling water should not be changed. Cooling water pressure should not exceed 0.8MPa. If the gearbox is stopped for a long time, or the water has a danger of freezing. Drain off the cooling water. You should blow moisture with compressed air.

5.3 Heating

At low temperature, it may be necessary to heat the lubrication oil in gearbox before starting the driving device of gearbox. Sometimes, it's need to heat the lubrication oil during operation. In these situations, you should equip one or two heating components. These heating components transfers electric energy into heat energy, thus heating the lubrication oil. Heating component is located in protective cover pipe inside the housing, so it's not necessary need to discharge lubrication oil in gearbox cabinet when changing heating component.

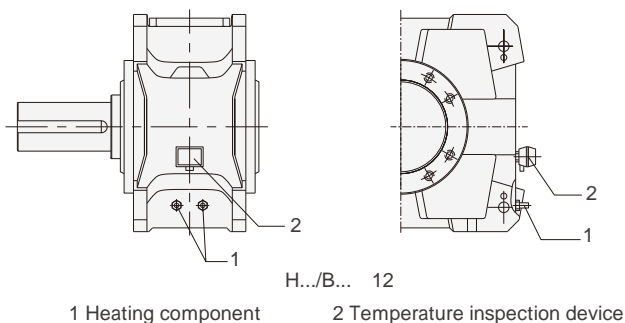

Note:

You can only connect power source of heating component when it is immersed in lubrication oil, otherwise, there may be fire danger. If you install heating component afterwards, the maximum heating capacity on the surface of heating component should not exceed $0.8\text{W}/\text{cm}^2$.

5.4 Backstop

In some situations, the gearbox should equip mechanical backstop. This can make gearbox run to one direction during operation. The rotation direction is marked in input and output end of gearbox with arrow. Backstop mechanism is installed on mounting flange plate of gearbox, it is sealed, with no oil leakage. It is united with lubrication oil circulation system.

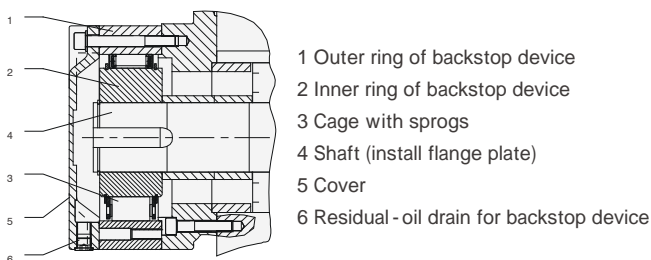

Note:

To avoid damaging backstop device or gearbox, the motor should not run to the forbidden direction, pay attention to the instruction on gearbox. Before motor wiring, you should determine rotation direction of three-phase power source with a phase-sequence indicator, connect motor wire according to the regulated rotation direction.

6 Application

6.1 Fill the lubrication oil

Our products are not filled with lubrication oil when delivered. You should fill lubrication oil according to instruction book before running.

On the position marked with this symbol, fill lubrication oil into gearbox.

6.2 Check the device

Check oil level, cooling of lubrication oil or the sealingness of oil supply system.

Inspect the status of cooling device and check the shut - off valve.

For the gearbox equipped with backstop device, inspect whether wiring of motor is correct.

Inspect whether shaft sealing is effective.

Check whether the rotating components contact with other components.

6.3 Start

For the gearbox equipped with motor oil pump, make sure open oil pump motor before starting the device.

Check whether the running direction under free status is correct (supervise whether there is abnormal grinding noise when the shaft is running).

During running inspection, you should ensure no output component on shaft, open relevant supervision and protection device at the same time.

If there is abnormal running phenomenon (for example, temperature rise, noise, vibration, etc), you should turn off the motor and check out the reason.

Contact with BONENG when necessary.

7 Checks and maintenance

7.1 Check and maintenance regularly

Users should make regular maintenance to gearbox. Check the status of lubrication oil regularly, clean vent cap, fan, cooling coil and the surface of gearbox, keep the gearbox clean, ensure normal running of gearbox.

7.2 Periods of checks and maintenance

Check oil temperature	Daily
Check abnormal noise of gearbox	Daily
Check oil level	Monthly
Check for leaks gearbox	Monthly
Check oil for water content	After working 400 hours, at least once a year

First oil change after starting	After working 400 hours
Subsequent oil changes	After every 5000 hours
Clean oil filter	Every 3 months
Clean ventilation cap	Every 3 months
Clean fan, fan cowl and gearbox cabinet	Do with oil changing
Check cooling coil for deposits	About every 2 years, do with oil changing
Check lubrication oil air cooler	Do with oil changing
Check lubrication oil water cooler	Do with oil changing
Check tightness of fastening bolts	The first time after changing oil, then change oil every two times
Full - aspect inspection to gearbox	About every 2 year, do with oil changing
Clean ventilation screw	Every 3 months

 The listed periods are determined on working condition of gearbox. These periods are average values under the following conditions:

- Daily working hour: 24 hours
- Loading factor: 100%
- Speed of input device 1800 RPM
- Maximum temperature 90 (only mineral oil)
100 (only synthetic oil)

7.3 Notes for checks and maintenance:

Cut off power source, prevent electric shock, wait for cooling of gearbox.

Inspection of oil level: screw down oil ruler, inspect oil level. Products which use oil glass refer the oil glass level and fill the oil to the middle level of oil glass.

Oil inspection: remove oil drain plug, take some samples, inspect oil viscosity index; if the oil is not clean, change it.

Oil changing:

It is forbidden to mix different lubricants.

After cooling, oil viscosity will increase, it is harder to drain off oil. change before cooling.

Put an oil picking plate under oil plug, tear down oil plug/oil ruler/vent cap, install oil plug after removing oil.

Inject new oil of the same brand, oil quantity should be the same with installation direction (see nameplate); if the brand number is different, consult after-sales department.

Inspect oil level at oil ruler or oil glass, install oil ruler and vent cap.

8 Fault treatment

8.1 Fault, reason and measures

Maintenance work should be done by qualified staff

Fault	Reason	Measure
Big noise at the fastener of gearbox	Fastener looses	Tighten bolt/nut to regulated torque. Replace the damaged bolt/nut.
Noise change of gearbox	Teeth of gear is damaged	Contact with customer service department. Check all the gears, change the damaged components.
	Bearing interval is too large	Contact with customer service department. Adjust bearing interval.
	Bearing is damaged	Contact with customer service department. Change the damaged bearings.
Operating temperature is too high	Oil level in cabinet is too high.	Check oil level, if necessary, adjust it.
	Oil is too old	Contact with customer service department. Check the last time of oil changing, if necessary, change it.
	Oil is badly contaminated.	Contact with customer service department Change oil
	On gearbox equipped with lubrication oil cooling system: Flow of coolant is too low or too high	Adjust the valve of inflow and outflow pipelines. Check free flow of water cooling device.
	Temperature of coolant is too high	Check the temperature and adjust according to requirements
	Oil flows through water cooling device is too low, reason: Oil filter is seriously clogged	Clean oil filter
	Mechanical fault of oil pump	Contact with customer service department. Check whether the function of oil pump is normal. Repair or change into a new one.
	On gearbox equipped with fan: Air inlet and/or cabinet of fan cover are badly contaminated	Clean fan cover and cabinet
Gearbox equipped with cooling coil: Residues dirt in cooling coil	Contact with customer service department. Clean or change cooling coil.	

Fault	Reason	Measure
Temperature of bearing is too high	Oil level in gearbox cabinet is too high or too low	Check oil level under room temperature and topup oil according to requirements
	Oil is too old	Contact with customer service department. Check the last time of oil changing.
	Mechanical fault of oil pump	Contact with customer service department. Check whether oil pump works normally. Repair or change a new oil pump
	Bearing is damaged	Contact with customer service department. Check the data obtained from vibration measurement by operators Check and change bearing according to requirements
Amplitude of bearing rises	Bearing is damaged	Contact with customer service department. Check and change bearing according to requirements.
	Gear is damaged	Contact with customer service department. Check and change gear according to requirements.
Temperature of backstop device is too high Backstop is ineffective.	Backstop device is damaged.	Contact with customer service department. Check and change backstop device according to requirements.
Gearbox leaks oil	Sealing at cabinet cover or joint is not good	Check sealing part and the joint, if necessary, change into a new one. Seal the joint part.
	Radial shaft sealing ring is ineffective.	Contact with customer service department. Change into a new radial sealing.
There is water in oil	Oil fams in pump	Check water contamination with test tube. Analyze oil in lab.
	Lubrication oil cooler or cooling coil is ineffective	Contact with customer service department. Find out and repair the leaking part. Change cooler or cooling coil.
	Gearbox occurs the cold air from ventilation, thus forming frost.	Protect the gearbox with appropriate thermal insulation material. Close air outlet or change its direction on structure.
Pressure supervision device alarms (gear-box equipped with pressure lubrication, lubrication oil water cooling device and air cooling device)	Oil pressure is less than 0.5bar	Check oil height under room temperature, fill in oil according to requirements.Check oil filter, change according to requirements. Contact with customer service department. Check whether oil pump function is normal. Repair or change oil pump.
Indicator of double changingfilter sends alarms	Double changing filter clogged	Change the filter according to instructions, remove clogged filter elemont and clean it.
Fault of oil supply system		Check the instructions of oil supply system in instruction book.

For the faults can ' t be removed by customers, please contact with after - sales department of the company.

After-sale service

For the various kinds of transmission devices, if there is any quality problem, don't tear down components, you should illustrate the situation, then contact with after-sales department of the company, confirm about the problems, then apply ideal method to deal with them.

Logging in " www.boneng.com "

Click " Service "

Click " After-sale Service "



BONENG TRANSMISSION(SHEN YANG)CO.,LTD

Controller/Drive : 024 - 31271571

Motor/Gear motor/Gearbox : 024 - 31292571

BONENG TRANSMISSION(TIAN JIN)CO.,LTD

Controller/Drive : 022 - 86928559

Motor/Gear motor/Gearbox : 022 - 26929558

BONENG TRANSMISSION(KAIFENG)CO.,LTD

Controller/Drive : 0371 - 23335230

Motor/Gear motor/Gearbox : 0371 - 23277771

BONENG TRANSMISSION(WEIFANG)CO.,LTD

Controller/Drive : 0536 - 4699687

Motor/Gear motor/Gearbox : 0536 - 4699667

BONENG TRANSMISSION(CHANGSHA)CO.,LTD

Controller/Drive : 0731 - 88386958

Motor/Gear motor/Gearbox : 0731 - 88380725

BONENG TRANSMISSION(SUZHOU)CO.,LTD

Controller/Drive Southern Jiangsu : 0512 - 66182005

Motor/Gear motor/Gearbox Southern Jiangsu : 0512 - 66189918

Controller/Drive Zhejiang - Shanghai : 0512 - 66182005

Motor/Gear motor/Gearbox Zhejiang - Shanghai : 0512 - 66189918

Controller/Drive Jiangsu - Anhui District : 0512 - 66182005

Motor/Gear motor/Gearbox Jiangsu - Anhui : 025 - 52171612

BONENG TRANSMISSION(USA/Canada)CO.,LTD

Technical Support/Debugging/After - Sales Service :

1250 E 222nd Euclid, OH 44117, United States

Email: America@boneng.com

Office Tel: 1-216-618-3099 / 1-216-618-0138

BONENG TRANSMISSION(India)CO.,LTD

Technical Support/Debugging/After - Sales Service :

Plot No. E - 10/3, MIDC sinner (Malegaon) Industrial Area,

Nashik, 422123, Maharashtra, India.

Email: india@boneng.com

Tel: +91 - 22 - 2781 3385 / +91 - 11 - 4507 6293

Other District

Controller/Drive : 0512 - 66182005

Motor/Gear motor/Gearbox : 0512 - 66189918

BONENG